

PROTEKT®

MANUFACTURER OF FALL PROTECTION EQUIPMENT

TOOL LANYARDS AND BAGS

7

**GET
BAG**

Transport sacks
Transport backpacks
Transport bags
Tool and transport bucket
Equipment covers bags
Arborist baskets
Transport sacks Dry Bag
Tool lanyards
Tool bags and belts

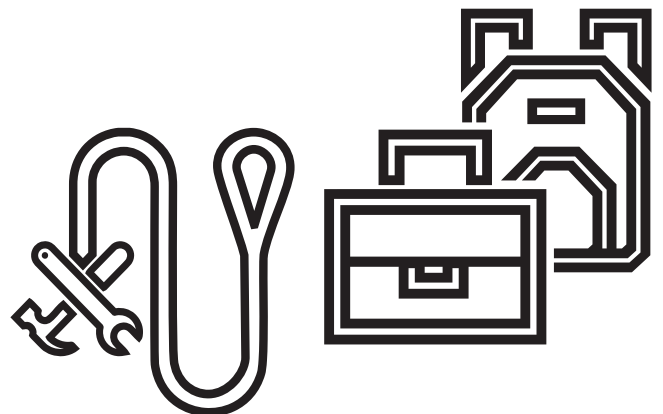

2023

Table of contents

The PROTEKT company has been present on the market for nearly 30 years and is specialized in fall protection equipment.

We focus mainly on safety and comfort of use of our products. This equipment is used in many industries for works at a height, depth and by rescue services and arborists (tree surgeons). Our offer includes both personal fall protection equipment – full body harnesses, energy absorbers, lanyards, and permanent anchorage systems.

Knowledge and skills of our personnel and professional research and manufacturing facilities ensure keeping the highest quality standards. At the same time, we try to offer products at attractive prices. All our products hold European certificates confirmed by both Polish and foreign notified bodies (including but not limited to CIOP, IPO, APAVE).



4	TRANSPORT SACKS
16	BACKPACKS
32	TRANSPORT BAGS
40	TOOL AND TRANSPORT BUCKETS
50	EQUIPMENT COVER BAGS
55	ARBORIST BASKETS

60	DRY BAGS
70	RETRACTABLE TOOL LANYARD
73	STEEL TOOL LANYARDS
77	TOOL BAGS AND BELTS
87	TOOL HOLDERS
94	TOOL BAGS AND BELTS

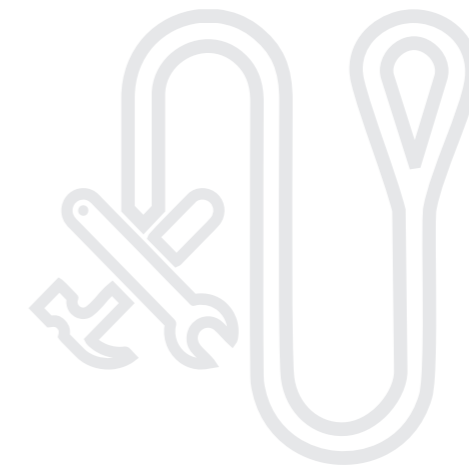



AX 008



AX 010



AX 011



AX 011D



AX 011N



AX 011K



AX 011T



AX 012



AX 013A



AX 013B



AX 024



AX 560 01



AX 560 02



AX 030 01



AX 030 02



AX 030 03

Transport sacks

AX 008

Transport sack

Capacity
16 litres

Ref no.: **AX 008**



DIMENSIONS

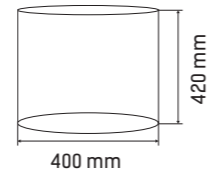

Available colors:

- YELLOW AX 008 01
- RED AX 008 02
- BLUE AX 008 03

Technical data:

MATERIAL:	reinforced PVC
WEIGHT:	400 g
DIMENSIONS:	420 x 400 mm
CAPACITY:	16 l

Equipment:

- adjustable shoulder straps,
- wide opening with a drawstring.

AX 010

Transport sack

Capacity
36 litres

Ref no.: **AX 010**



DIMENSIONS

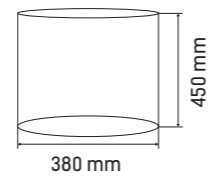

Available colors:

- YELLOW AX 010 01
- RED AX 010 02
- BLUE AX 010 03

Technical data:

MATERIAL:	reinforced PVC
WEIGHT:	600 g
DIMENSIONS:	450 x 380 mm
CAPACITY:	36 l

Equipment:

- adjustable shoulder straps,
- wide opening with a drawstring.

AX 011

Transport sack

Capacity
33 litres

Ref no.: **AX 011**



DIMENSIONS

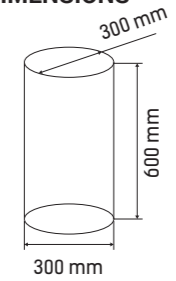

Available colors:

- YELLOW AX 011 01
- RED AX 011 02
- BLUE AX 011 03

Technical data:

MATERIAL:	reinforced PVC
WEIGHT:	550 g
DIMENSIONS:	600 x 300 x 300 mm
CAPACITY:	33 l

Equipment:

- adjustable shoulder straps,
- wide opening with a drawstring.

AX 011D

Transport sack

Capacity
33 litres

Ref no.: **AX 011D**



DIMENSIONS

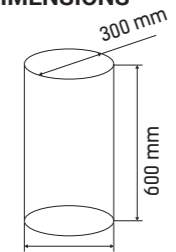

Available colors:

- YELLOW AX 011D 01
- RED AX 011D 02
- BLUE AX 011D 03

Technical data:

MATERIAL:	reinforced PVC
WEIGHT:	850 g
DIMENSIONS:	600 x 300 x 300 mm
CAPACITY:	33 l

Equipment:

- adjustable shoulder straps,
- wide opening with a drawstring,
- outer, transparent pocket, fastened with a zip,
- lid fastened with velcro.

AX 011N

Transport sack

Capacity
33 litres

Ref no.: **AX 011N**



DIMENSIONS

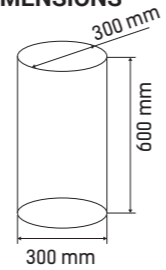

Available colors:

- YELLOW
AX 011N 01
- RED
AX 011N 02
- BLUE
AX 011N 03

Technical data:

MATERIAL:	einforced PVC
WEIGHT:	600 g
DIMENSIONS:	600 x 300 x 300 mm
CAPACITY:	33 l

Equipment:

- adjustable shoulder straps,
- wide opening with a drawstring,
- tool straps.

AX 011K

Transport sack

Capacity
33 litres

Ref no.: **AX 011K**



DIMENSIONS

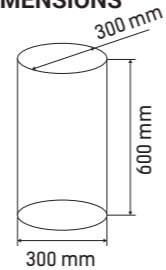

Available colors:

- YELLOW
AX 011K 01
- RED
AX 011K 02
- BLUE
AX 011K 03

Technical data:

MATERIAL:	einforced PVC
WEIGHT:	650 g
DIMENSIONS:	600 x 300 x 300 mm
CAPACITY:	33 l

Equipment:

- adjustable shoulder straps,
- wide opening with a drawstring,
- additional collar with a drawstring,
- two tape straps allowing to hang the bag.

AX 011T

Transport sack

Capacity
30 litres

Ref no.: **AX 011T**



DIMENSIONS

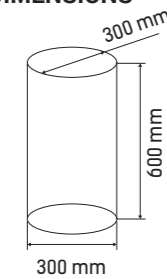

Available colors:

- YELLOW
AX 011T 01
- CZERWONY
AX 011T 02
- BLUE
AX 011T 03

Technical data:

MATERIAL:	einforced PVC
WEIGHT:	720 g
DIMENSIONS:	600 x 300 x 300 mm
CAPACITY:	30 l

Equipment:

- adjustable shoulder straps,
- bag fastened with a zip,
- „D” type steel buckle.

AX 012

Transport sack

Capacity
80 litres

Ref no.: **AX 012**



DIMENSIONS

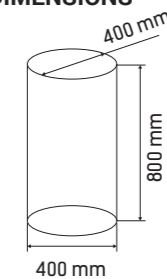

Available colors:

- YELLOW
AX 012 01
- RED
AX 012 02
- BLUE
AX 012 03

Technical data:

MATERIAL:	einforced PVC
WEIGHT:	950 g
DIMENSIONS:	800 x 400 x 400 mm
CAPACITY:	80 l

Equipment:

- adjustable shoulder straps,
- wide opening with a drawstring.

AX 013B

Transport sack

Capacity
26 litres

Ref no.: **AX 013B**



DIMENSIONS

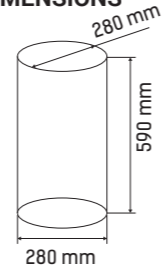

Available colors:

- YELLOW
AX 013B 01
- RED
AX 013B 02
- BLUE
AX 013B 03

Technical data:

MATERIAL:	einforced PVC
WEIGHT:	740 g
DIMENSIONS:	590 x 280 x 280 mm
CAPACITY:	26 l

Equipment:

- adjustable shoulder straps,
- wide opening with a drawstring,
- inner, transparent pocket.

AX 024

Transport sack

Capacity
25 litres

Ref no.: **AX 024**



clear pocket
zippered flashlight



DIMENSIONS

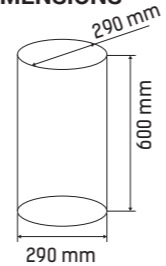

Available colors:

- YELLOW/BLACK
AX 024 11
- ORANGE/BLACK
AX 024 15
- RED/BLACK
AX 024 12

Technical data:

MATERIAL:	einforced PVC
WEIGHT:	1150 g
DIMENSIONS:	600 x 290 x 290 mm
CAPACITY:	25 l

Equipment:

- wide opening with a drawstring,
- adjustable, removable arm strap,
- side pocket fastened with a zip,
- trimmed edge of the opening.

AX 013A

Transport sack

Capacity
20 litres

Ref no.: **AX 013A**



fastened with a zip



inner,
transparent
pocket



DIMENSIONS

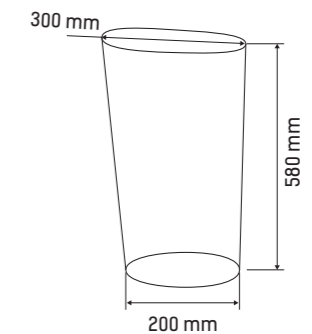

Available colors:

- YELLOW
AX 013A 01
- RED
AX 013A 02
- BLUE
AX 013A 03

Technical data:

MATERIAL:	einforced PVC
WEIGHT:	540 g
DIMENSIONS:	580 x 300 x 200 mm
CAPACITY:	20 l

Equipment:

- adjustable arm strap with a cushion,
- bag fastened with a zip,
- inner, transparent pocket.

AX 560 10

Transport sack

Capacity
45 litres

Ref no.: **AX 560 10**



DIMENSIONS

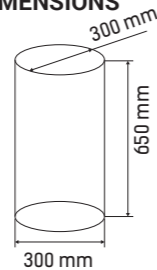

Technical data:

MATERIAL:	plavil / PVC
WEIGHT:	1220 g
DIMENSIONS:	650 x 300 x 300 mm
CAPACITY:	45 l
SAFETY FACTOR:	7:1
LIFTING CAPACITY:	300 kg

Equipment:

- tight closure fastened with a buckle,
- four strap handles for hanging the sack.

AX 560 20

Transport sack

Capacity
150 litres

Ref no.: **AX 560 20**



DIMENSIONS

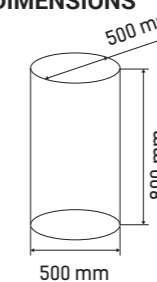

Technical data:

MATERIAL:	plavil / PVC
WEIGHT:	2020 g
DIMENSIONS:	800 x 500 x 500 mm
CAPACITY:	150 l
SAFETY FACTOR:	7:1
LIFTING CAPACITY:	300 kg

Equipment:

- tight closure fastened with a buckle,
- four strap handles for hanging the sack.

AX 030 01

Transport sack

Capacity
15 litres



Ref no.: AX 030 01

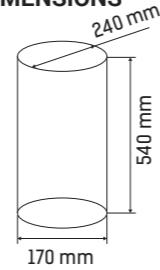

DIMENSIONS



Available colors:

-  WHITE/BLACK
AX 030 10 20
-  WHITE/RED
AX 030 10 21
-  WHITE/GREEN
AX 030 10 22

Technical data:

MATERIAL:	einforced PVC
WEIGHT:	660 g
DIMENSIONS:	540 x 240 x 170 mm
CAPACITY:	15 l

Equipment:

- fastening with a buckle,
- wide opening with a drawstring,
- transparent pocket.

AX 030 02

Worek transportowy

Capacity
30 litres



Ref no.: AX 030 02

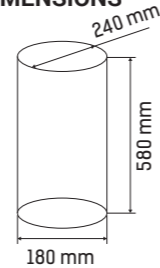

DIMENSIONS



Available colors:

-  WHITE/BLACK
AX 030 20 20
-  WHITE/RED
AX 030 20 21
-  WHITE/GREEN
AX 030 20 22

Technical data:

MATERIAL:	einforced PVC
WEIGHT:	760 g
DIMENSIONS:	580x 240 x 180 mm
CAPACITY:	30 l

Equipment:

- fastening with a buckle,
- wide opening with a drawstring,
- transparent pocket.

AX 030 03

Transport sack

Capacity
45 litres

Ref no.: AX 030 03





strong lateral handles

transparent pouch

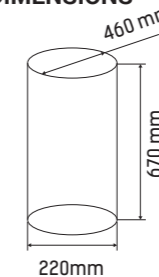
DIMENSIONS



Available colors:

-  WHITE/BLACK
AX 030 30 20
-  WHITE/RED
AX 030 30 21
-  WHITE/GREEN
AX 030 30 22

Technical data:

MATERIAL:	einforced PVC
WEIGHT:	1190 g
DIMENSIONS:	670 x 460 x 220 mm
CAPACITY:	45 l

Equipment:

- fastening with a buckle,
- wide opening with a drawstring,
- transparent pocket,
- side handles.



AX 011S



AX 011SP



AX 020



AX 074



AX 070



AX 070L



AX 040



AX 075



AX 071



AX 080



TA 400



TA 703



TA 704



TA 705



TA 706



TA 707



MX 001



MX 002



MX 003

Backpack

AX 011S

Large capacity backpack

Capacity

45 litres



Ref no.: **AX 011S**

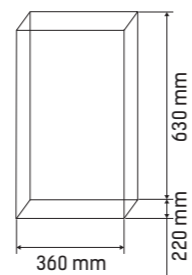

DIMENSIONS



Available colors:

-  YELLOW/BLACK
AX 011S 11
-  ORANGE/BLACK
AX 011S 15
-  RED/BLACK
AX 011S 12

Technical data:

MATERIAL:	einforced PVC
WEIGHT:	1180 g
DIMENSIONS:	630 x 360 x 220 mm
CAPACITY:	45 l

Equipment:

- wide opening with a drawstring,
- adjustable shoulder straps,
- adjustable hip strap with cushions and a buckle,
- inner padding on the back,
- upper flap closed with a buckle.

AX 011SP

Large capacity backpack

Capacity

60 litres



Ref no.: **AX 011SP**

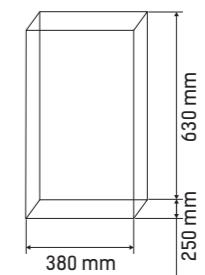

DIMENSIONS



Available colors:

-  YELLOW
AX 011SP 01
-  RED
AX 011SP 02
-  ORANGE
AX 011SP 05

Technical data:

MATERIAL:	einforced PVC
WEIGHT:	1640 g
DIMENSIONS:	630 x 380 x 250 mm
CAPACITY:	60 l

Equipment:

- wide opening with a drawstring,
- adjustable shoulder straps,
- adjustable hip strap with cushions,
- inner padding on the back,
- two side pockets fastened with velcro,
- upper flap closed with a buckle.

AX 020

Backpack

Capacity
35 litres

Ref no.: **AX 020**



DIMENSIONS

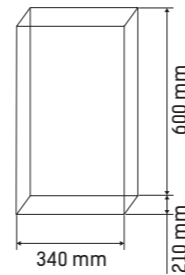

Equipment:

- adjustable shoulder straps,
- zippered flap,
- a rubber grip on top of the backpack,
- inner lining on the back,
- high visibility.

Technical data:

MATERIAL:	einforced PVC
WEIGHT:	1200 g
DIMENSIONS:	600 x 340 x 210 mm
CAPACITY:	35 l

Available colors:



AX 070L

Large capacity backpack

Capacity
40 litres

Ref no.: **AX 070L**



DIMENSIONS

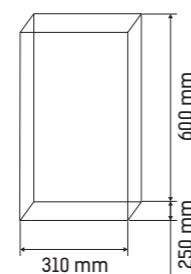

Available colors:

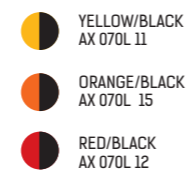

Equipment:

- adjustable shoulder straps,
- sewn-in breathing cushion, increasing the comfort of wearing,
- 2 chainsaw pockets,
- convenient snap hook attachment system,
- removable bottom,
- lid closed with a buckle.

Technical data:

MATERIAL:	einforced PVC
WEIGHT:	1500 g
DIMENSIONS:	600 x 310 x 250 mm
CAPACITY:	40 l

AX 040

Large capacity backpack

Capacity
45 litres

Ref no.: **AX 040**



tight rolling closure

DIMENSIONS

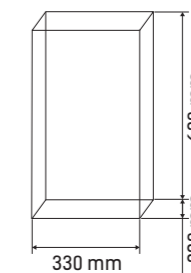

Available colors:

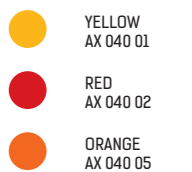

Equipment:

- tight rolling closure,
- adjustable shoulder straps,
- inner lining on the back,
- side pocket with velcro closure,
- inner transparent pocket.

Technical data:

MATERIAL:	einforced PVC
WEIGHT:	1150 g
DIMENSIONS:	620 x 330 x 220 mm
CAPACITY:	45 l

AX 070

Large capacity backpack

Capacity
40 litres

Ref no.: **AX 070**





2 chainsaw pocket

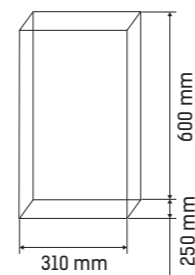

DIMENSIONS



Available colors:

-  YELLOW/BLACK
AX 070 11
-  ORANGE/BLACK
AX 070 15
-  RED/BLACK
AX 070 12

Technical data:

MATERIAL:	einforced PVC
WEIGHT:	1490 g
DIMENSIONS:	600 x 310 x 250 mm
CAPACITY:	40 l

Equipment:

- sewn-in breathing cushion, increasing the comfort of wearing,
- 2 chainsaw pockets,
- convenient snap hook attachment system,
- removable bottom,
- lid closed with a buckle.

AX 071

Transport backpack

Capacity
30 litres



Ref no.: **AX 071**

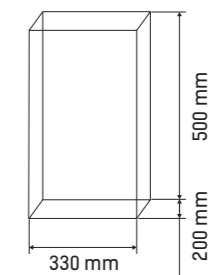

DIMENSIONS



Available colors:

-  ORANGE/NAVY BLUE
AX 071 18
-  NAVY BLUE/BLACK
AX 071 17
-  BLACK/ORANGE
AX 071 15

Technical data:

MATERIAL:	einforced PVC
WEIGHT:	1150 g
DIMENSIONS:	500 x 330 x 200 mm
CAPACITY:	30 l

Equipment:

- sewn in breathable cushion for improved comfort,
- convenient snap hook attachment system,
- additional transparent pocket,
- lid closed with buckle and puller.

AX 080

Arborist backpack

Capacity
80 litres

Ref no.: **AX 080**

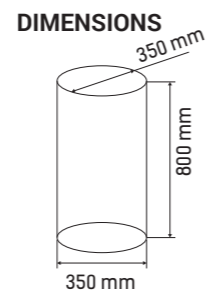

Available colors:

- YELLOW
AX 080 01
- RED
AX 080 02
- BLACK
AX 080 04

Technical data:

MATERIAL:	polyester
WEIGHT:	2600 g
DIMENSIONS:	800 x 350 x 350 mm
CAPACITY:	80 l

Equipment:

- adjustable shoulder straps,
- 5 inner pockets,
- possibility of separating the backpack (2 separable baskets),
- convenient wearing handles.

TA 400

Transport backpack

Capacity
35 litres

Ref no.: **TA 400**

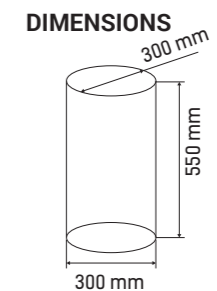

Available colors:

- YELLOW
TA 400 01
- RED
TA 400 02
- BLACK
TA 400 04

Technical data:

MATERIAL:	reinforced PVC
WEIGHT:	620 g
DIMENSIONS:	550 x 300 x 300 mm
CAPACITY:	35 l

Equipment:

- swide opening with additional collar and a drawstring
- adjustable shoulder straps,
- lid closed with two bukcles.

MX 001

Medical backpack

NEW

Capacity
35 litres

Ref no.: **MX 001**



Equipment:

- fastening with a zipper,
- numerous pockets inside,
- the possibility of any interior arrangement of the backpack through detachable organizers

Technical data:

MATERIAL:	reinforced PVC
WEIGHT:	2300 g
DIMENSIONS:	500 x 400 x 190 mm
CAPACITY:	35 l

NEW

MX 002

Fold-out medical bag

Ref no.: **MX 002**



Equipment:

- fastening with a buckle,
- 3 inner pockets with zippers.

Technical data:

MATERIAL:	polyester
WEIGHT:	160 g
CAPACITY:	240 x 200 x 45 mm

MX 003

A handy first aid kit

NEW

Ref no.: **MX 003**



Equipment:

- fastening with a zipper,
- 2 inside pockets,
- possibility of attaching to the belt.

Technical data:

MATERIAL:	polyester
WEIGHT:	125 g
DIMENSIONS:	150 x 100 x 50mm

AX 074

Transport backpack

Ref no.: **AX 074**

Capacity
60 litres



Equipment:

- adjustable shoulder straps,
- front pockets with zippers,
- inside pocket with zipper with transparent wal,
- front and rear handle
- extendable collar,
- high-strength construction.

Technical data:

MATERIAL:	reinforced PVC
WEIGHT:	2600 g
DIMENSIONS:	720 x 330 x 330 mm
CAPACITY:	60 l

AX 075

Transport backpack

Capacity
40 litres

Ref no.: AX 075

QUICK ACCESS TO EQUIPMENT INSIDE BACKPACK!



Equipment:

- adjustable shoulder straps,
- wide loading opening,
- numerous pockets and attachment points inside the backpack,
- front flaps closed with a zipper
- upper transport handle.

Technical data:

MATERIAL:	reinforced PVC
WEIGHT:	1880 g
DIMENSIONS:	600 x 380 x 190mm
CAPACITY:	40 l

TA 706

Foldable backpack

NEW

Capacity
12 litres

Ref no.: TA 706



DIMENSIONS

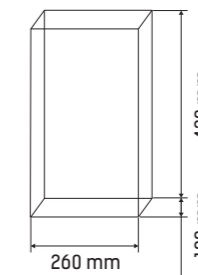

Equipment:

- fastening with a zipper and a buckle,
- inner pocket,
- can be packed into an inner satchel.

Technical data:

MATERIAL:	Ripstop
WEIGHT:	400 g
DIMENSIONS:	430 x 260 x 100 mm
CAPACITY:	12 l

TA 707

Foldable lightweight backpack

NEW

Capacity
10 litres

Ref no.: TA 707



DIMENSIONS

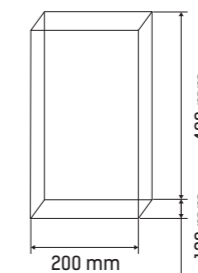

Equipment:

- fastening with a zipper,
- 2 outer pockets,
- inner pocket,
- the possibility of packing for the inner satchel.

Technical data:

MATERIAL:	Ripstop
WEIGHT:	250 g
DIMENSIONS:	400 x 200 x 120 mm
CAPACITY:	10 l

TA 703

Transport backpack

NEW

Capacity
15 litres

Ref no.: TA 703



DIMENSIONS

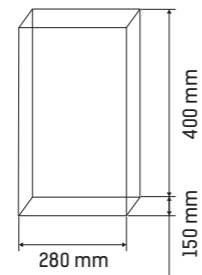

Technical data:

MATERIAL:	polyester
WEIGHT:	400 g
DIMENSIONS:	400 x 280 x 150 mm
CAPACITY:	15 l

Equipment:

- fastening with a zipper,
- additional outside pocket,
- side mesh pocket.

TA 705

Transport backpack

NEW

Capacity
25 litres

Ref no.: TA 705



DIMENSIONS

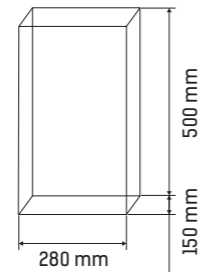

Technical data:

MATERIAL:	polyester
WEIGHT:	600 g
DIMENSIONS:	500 x 300 x 160 mm
CAPACITY:	25 l

Equipment:

- fastening with a zipper,
- side outer pocket.

TA 704

One-shoulder backpack

NEW

Capacity
15 litres

Ref no.: TA 704



removable organizer for photo equipment

inner compartment on the tablet



DIMENSIONS

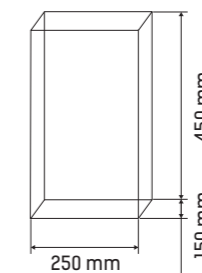

Technical data:

MATERIAL:	polyester
WEIGHT:	700 g
DIMENSIONS:	450 x 250 x 150 mm
CAPACITY:	15 l

Equipment:

- fastening with a zipper,
- additional outer pocket,
- softly padded back
- inner tablet compartment,
- removable internal organizer for photo equipment.



AX 014



AX 028



AX 023



AX 301



AX 026



AX 050



AX 100



AX 200



AX 800



AX 801



TA 301



TA 302

Transport bags

AX 014

Tool bag

Capacity

10 litres

Ref no.: **AX 014**



DIMENSIONS

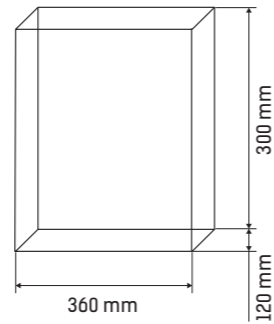

Available colors:

- YELLOW
AX 014 01
- RED
AX 014 02
- BLACK
AX 014 04

Technical data:

MATERIAL:	einforced PVC
WEIGHT:	480 g
DIMENSIONS:	300 x 360 x 120 mm
CAPACITY:	10 l

Equipment:

- 2 compartments,
- air vents on the bottom of the bag,
- flap fastened with velcro.

AX 028

Transport bag

Capacity

50 litres

Ref no.: **AX 028**



DIMENSIONS

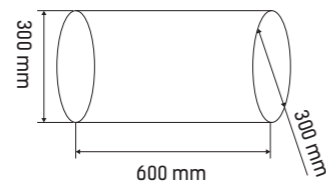

Available colors:

- YELLOW
AX 010 01
- RED
AX 010 02
- PINK
AX 010 20

Technical data:

MATERIAL:	einforced PVC
WEIGHT:	865 g
DIMENSIONS:	300 x 300 x 600 mm
CAPACITY:	50 l

Equipment:

- two non-adjustable handles for carrying,
- additional rubber handles on the sides of the bag,
- 1 compartment,
- bag fastened with a zip.

NEW

AX 023

Transport bag

Capacity

25 litres

Ref no.: **AX 023**



DIMENSIONS

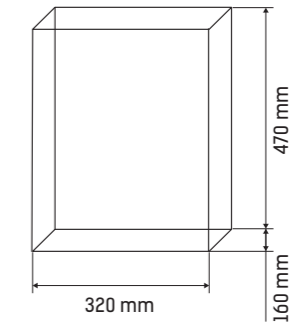

Available colors:

- YELLOW
AX 023 01
- RED
AX 023 02
- BLACK
AX 023 04

Technical data:

MATERIAL:	einforced PVC
WEIGHT:	820 g
DIMENSIONS:	470 x 320 x 160 mm
CAPACITY:	25 l

Equipment:

- adjustable shoulder strap,
- 1 compartment,
- reinforced bottom,
- flap closed with a buckle.

AX 050

Transport bag

Capacity

10 litres

Ref no.: **AX 050**



DIMENSIONS

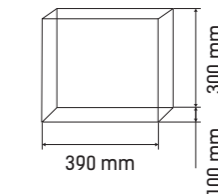

Available colors:

- YELLOW
AX 050 01
- RED
AX 050 02
- BLUE
AX 050 03

Technical data:

MATERIAL:	polyester
WEIGHT:	350 g
DIMENSIONS:	300 x 100 x 390 mm
CAPACITY:	10 l

Equipment:

- adjustable shoulder strap,
- 1 compartment,
- flap closed with a buckle.

AX 026

Tool bag

Capacity
10 litres

Ref no.: **AX 026**



Available colors:

- YELLOW
AX 026 01
- RED
AX 026 02
- BLACK
AX 026 04

Equipment:

- velcro closure flap,
- divided inner pocket with 4 steel hooks,
- 4 external steel hooks,
- 2 front pockets with velcro closure.



Technical data:

MATERIAL:	einforced PVC
WEIGHT:	960 g
DIMENSIONS:	300 x 300 x 100 mm
CAPACITY:	10 l

AX 100

Transport bag

Capacity
25 litres

Ref no.: **AX 100**



DIMENSIONS

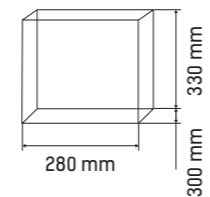

Available colors:

- YELLOW
AX 100 01
- RED
AX 100 02
- BLUE
AX 100 03

Equipment:

- adjustable shoulder strap,
- reinforced bottom and sides,
- 1 compartment,
- flap closed with a buckle.

Technical data:

MATERIAL:	einforced PVC
WEIGHT:	950 g
DIMENSIONS:	330 x 280 x 300 mm
CAPACITY:	25 l

AX 200

Tool bag

Capacity
5 litres

Ref no.: **AX 200**



Available colors:

- YELLOW
AX 200 01
- RED
AX 200 02
- BLACK
AX 200 04

Equipment:

- two non-adjustable handles for carrying,
- 1 compartment,
- bag fastened with a zip.

Technical data:

MATERIAL:	polyester
WEIGHT:	140 g
DIMENSIONS:	280 x 270 x 90 mm
CAPACITY:	5 l

AX 801

Weight bag

Capacity
5 litres

Ref no.: **AX 801**



Available colors:

- YELLOW
AX 801 01
- RED
AX 801 02
- BLUE
AX 801 03

Equipment:

- drawstring,
- 1 compartment,
- additional mounting bracket.

Technical data:

MATERIAL:	einforced PVC
WEIGHT:	120 g
DIMENSIONS:	260 x 130 x 130 mm
CAPACITY:	5 l

AX 301

Transport bag

Capacity

50 litres

Ref no.: **AX 301**

DIMENSIONS

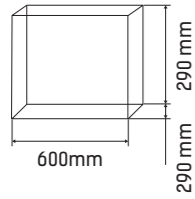

Equipment:

- adjustable shoulder strap,
- additional handles on the sides of the bag,
- soft padding of the whole,
- 1 compartment,
- effective strips,
- zippered flap,
- inside and outside transparent zippered pocket,
- additional inner pockets.

Available colors:

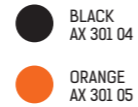

Technical data:

MATERIAL:	synthetic technical fabric
WEIGHT:	1100 g
DIMENSIONS:	290 x 290 x 600 mm
CAPACITY:	50 l

AX 800

Collapsible rope bag

Capacity

8 litres

Ref no.: **AX 800**



handles for suspension bag



reflective tape

Available colors:

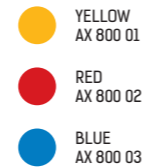

Technical data:

MATERIAL:	polyester
WEIGHT:	300 g
DIMENSIONS:	370 x 200 x 200 mm
CAPACITY:	8 l

Equipment:

- adjustable shoulder strap,
- wide opening with a drawstring,
- additional pocket fastened with velcro,
- reflective tape at the bottom of the bag,
- 1 compartment,
- handles for hanging.

TA 301

Tool bag

Capacity

10 litres

Ref no.: **TA 301**

DIMENSIONS

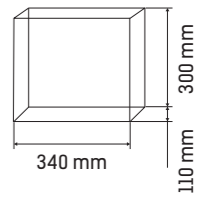

Available colors:

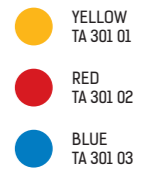

Technical data:

MATERIAL:	einforced PVC
WEIGHT:	300 g
DIMENSIONS:	300 x 340 x 110 mm
CAPACITY:	10 l

Equipment:

- side pocket,
- 1 compartment,
- 2 sewn-in carabiners.

TA 302

Tool bag

Capacity

10 litres

Ref no.: **TA 302**

DIMENSIONS

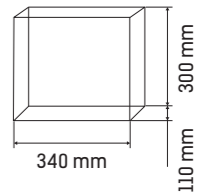

Available colors:

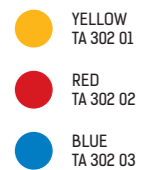

Technical data:

MATERIAL:	einforced PVC
WEIGHT:	400 g
DIMENSIONS:	300 x 340 x 110 mm
CAPACITY:	10 l

Equipment:

- side pocket,
- 2 compartments,
- 2 sewn-in carabiners.



Tool and transport buckets

TA 501 10

Small canvas tool bucket

Capacity
10 litres

Ref no.: **TA 501 10**



DIMENSIONS

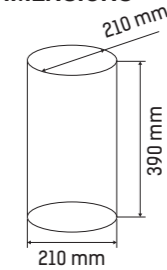

Available colors:

- BLACK
TA 501 10 04
- NATURAL
TA 501 10 06

Equipment:

- 1 compartment,
- reinforced plastic bottom,
- carry handle,
- rigid upper edge.

Technical data:

MATERIAL:	cotton
WEIGHT:	500 g
DIMENSIONS:	390 x 210 x 210 mm
CAPACITY:	10 l

TA 501 10W

Small canvas tool bucket

Capacity
10 litres

Ref no.: **TA 501 10W**



DIMENSIONS

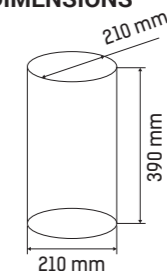

Available colors:

- BLACK
TA 501 10W 04
- NATURAL
TA 501 10W 06

Equipment:

- 1 compartment,
- reinforced plastic bottom,
- carry handle,
- rigid upper edge, reinforced with PVC.

Technical data:

MATERIAL:	cotton
WEIGHT:	520 g
DIMENSIONS:	390 x 210 x 210 mm
CAPACITY:	10 l

TA 501 20

Small PVC tool bucket

Capacity
10 litres

Ref no.: TA 501 20



DIMENSIONS

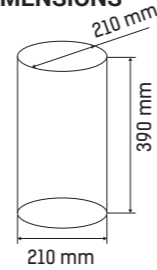

Available colors:

- YELLOW
TA 501 20 01
- RED
TA 501 20 02
- BLACK
TA 501 20 04

Technical data:

MATERIAL:	einforced PVC
WEIGHT:	580 g
DIMENSIONS:	390 x 210 x 210 mm
CAPACITY:	10 l

Equipment:

- 1 compartment,
- reinforced plastic bottom,
- carry handle,
- rigid upper edge.

TA 501 30

Small tool bucket

Capacity
10 litres

Ref no.: TA 501 30



DIMENSIONS

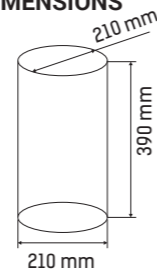

Available colors:

- YELLOW
TA 501 30 01
- RED
TA 501 30 02
- BLACK
TA 501 30 04

Technical data:

MATERIAL:	synthetic technical fabric, PCV
WEIGHT:	460 g
DIMENSIONS:	390 x 210 x 210 mm
CAPACITY:	10 l

Equipment:

- 1 compartment,
- reinforced plastic bottom,
- carry handle,
- rigid upper edge.

TA 501 30K

Small tool bucket with snap hook

Capacity
10 litres

Ref no.: TA 501 30K



DIMENSIONS

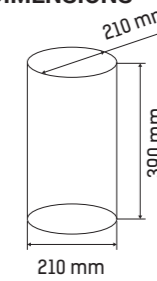

Available colors:

- YELLOW
TA 501 30K 01
- RED
TA 501 30K 02
- CZARNY
TA 501 30K 04

Technical data:

MATERIAL:	synthetic technical fabric, PCV
WEIGHT:	520 g
DIMENSIONS:	390 x 210 x 210 mm
CAPACITY:	10 l

Equipment:

- 1 compartment,
- KA10 or AZ 011 snap hook.
- rigid upper edge, PVC reinforced.

TA 501 40

Small tool bucket with snap hook

Capacity
4 litres

Ref no.: TA 501 40



DIMENSIONS

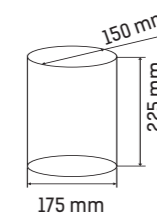

Available colors:

- YELLOW
TA 501 40 01
- RED
TA 501 40 02
- BLACK
TA 501 40 04

Technical data:

MATERIAL:	synthetic technical fabric, PCV
WEIGHT:	620 g
DIMENSIONS:	225 x 175 x 150 mm
CAPACITY:	4 l

Equipment:

- 1 compartment,
- KA10 snap hook,
- rigid upper edge.

TA 501 60

Small PCV tool bucket

Capacity
4 litres

Ref no.: TA 501 60



DIMENSIONS

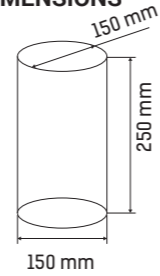

Available colors:

- YELLOW
TA 501 60 01
- RED
TA 501 60 02
- BLACK
TA 501 60 04

Technical data:

MATERIAL:	einforced PVC
WEIGHT:	320 g
DIMENSIONS:	250 x 150 x 150 mm
CAPACITY:	4 l

Equipment:

- 1 compartment,
- reinforced plastic bottom,
- handle with the possibility of attaching the snap hook.

TA 501 50

Small PCV tool bucket with snap hook

Capacity
3 litres

Ref no.: TA 501 50



DIMENSIONS

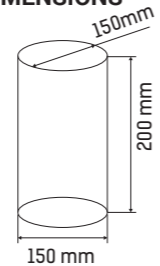

Available colors:

- YELLOW
TA 501 50 01
- RED
TA 501 50 02
- BLACK
TA 501 50 04

Technical data:

MATERIAL:	einforced PVC
WEIGHT:	320 g
DIMENSIONS:	200 x 150 x 150 mm
CAPACITY:	3 l

Equipment:

- 1 compartment,
- handle with KA10 snap hook.

TA 502 10

Big canvas tool bucket

Capacity
25 litres

Ref no.: TA 502 10



DIMENSIONS

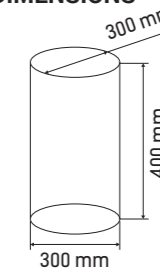

Available colors:

- BLACK
TA 502 10 04
- NATURAL
TA 502 10 06

Technical data:

MATERIAL:	cotton canvas
WEIGHT:	900 g
DIMENSIONS:	400 x 300 x 300 mm
CAPACITY:	25 l

Equipment:

- 2 inner pockets,
- 1 compartment,
- 2 outer pockets,
- reinforced plastic bottom,
- carry handle,
- rigid upper edge.

TA 502 40

Big canvas tool bucket

Capacity
25 litres

Ref no.: TA 502 40



DIMENSIONS

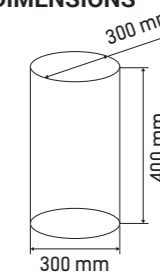

Available colors:

- NATURAL
TA 502 40 06
- BLACK
TA 502 40 04

Technical data:

MATERIAL:	cotton canvas
WEIGHT:	960 g
DIMENSIONS:	400 x 300 x 300 mm
CAPACITY:	25 l

Equipment:

- 2 inner pockets,
- 1 compartment,
- 2 outer pockets,
- collar with drawstring closure,
- reinforced plastic bottom,
- carry handle,
- rigid upper edge.

TA 502 20

Big PVC tool bucket

Capacity
25 litres

Ref no.: TA 502 20



DIMENSIONS

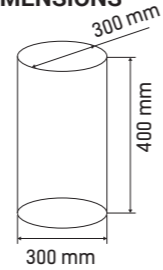

Available colors:

- YELLOW
TA 502 20 01
- RED
TA 502 20 02
- BLACK
TA 502 20 04

Technical data:

MATERIAL:	einforced PVC
WEIGHT:	1120 g
DIMENSIONS:	400 x 300 x 300 mm
CAPACITY:	25 l

Equipment:

- 2 inner pockets,
- 1 compartment,
- 2 outer pockets,
- reinforced plastic bottom,
- carry handle,
- rigid upper edge.

TA 502 10

Big tool bucket

Capacity
25 litres

Ref no.: TA 502 10



DIMENSIONS

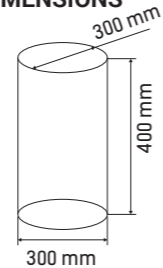

Available colors:

- YELLOW
TA 502 10 01
- RED
TA 502 10 02
- BLACK
TA 502 10 04

Technical data:

MATERIAL:	synthetic technical fabric, PCV
WEIGHT:	1000 g
DIMENSIONS:	400 x 300 x 300 mm
CAPACITY:	25 l

Equipment:

- 2 inner pockets,
- 1 compartment,
- 2 outer pockets,
- reinforced plastic bottom,
- carry handle,
- rigid upper edge.

TA 504 10

PVC tool bucket

Capacity
14 litres

Ref no.: TA 504 10



DIMENSIONS

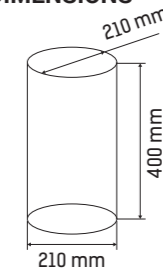

Available colors:

- YELLOW
TA 504 10 01
- RED
TA 504 10 02
- BLACK
TA 504 10 04

Technical data:

MATERIAL:	PCW
WAGA:	430 g
WYMIARY:	400 x 210 x 210 mm
POJEMNOŚĆ:	14 l

Equipment:

- 1 compartment,
- reinforced plastic bottom.

TA 504 20

PVC tool bucket

Capacity
21 litres

Ref no.: TA 504 20



DIMENSIONS

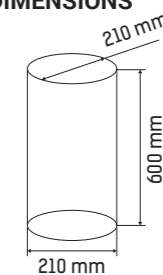

Available colors:

- ŻÓŁTY
TA 504 20 01
- RED
TA 504 20 02
- BLACK
TA 504 20 04

Technical data:

MATERIAL:	PVW
WAGA:	520 g
WYMIARY:	600 x 210 x 210 mm
POJEMNOŚĆ:	21 l

Equipment:

- 1 compartment,
- reinforced plastic bottom.

TA 501 10K

Tool bucket with collar

NEW

Capacity
10 litres

Ref no.: TA 501 10K



DIMENSIONS

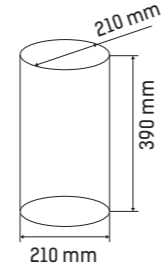

- Available colors:
-  BLACK
TA 501 10K 04
 -  NATURAL
TA 501 10K 06

Technical data:

MATERIAL:	cotton canvas
WEIGHT:	1120 g
DIMENSIONS:	400 x 300 x 300 mm
CAPACITY:	25 l

Equipment:

- 1 chamber,
- reinforced plastic bottom,
- carrying handle,
- collar with drawstring closure.

TA 502 60

Large tool bucket made of codura

NEW



Capacity
25 litres

Ref no.: TA 502 60

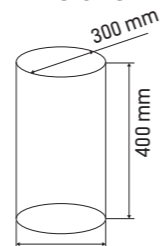

DIMENSIONS



- Available colors:
-  YELLOW
TA 502 60 01
 -  RED
TA 502 60 02
 -  BLACK
TA 502 60 04

Technical data:

MATERIAL:	codura, PVC
WEIGHT:	1080 g
DIMENSIONS:	400 x 300 x 300 mm
CAPACITY:	25 l

Equipment:

- 1 chamber,
- 2 inside pockets,
- 2 outer pockets,
- reinforced plastic bottom,
- carrying handle,
- stiffened upper edge, reinforced with PVC.

TA 601 10,15,20

Tool baskets made of codura

NEW

Technical data:

Ref no.:	TA 601 10	TA 601 15	TA 601 20
Weight:	100 g	160 g	200 g
Dimensions:	100x100x200cm	150x150x200cm	200x200x300cm
Capacity:	1,5 l	3,5 l	9 l

DIMENSIONS

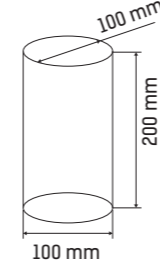

Capacity
1,5 litres

DIMENSIONS

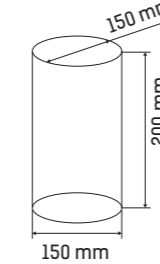

Capacity
3,5 litres

DIMENSIONS

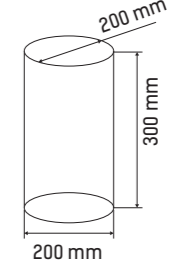

Capacity
9 litres



TA 601 10



TA 601 15



TA 601 20

Equipment:

- 1 chamber,
- catch handle



Equipment cover bags

AXS 100

Fire hose cover

Capacity
25 litres

Ref no.: **AXS 100**



Equipment:

- cover fastened with a zip,
- additional compression straps,
- transparent window.

Technical data:

MATERIAL:	reinforced PVC
WEIGHT:	740 g
DIMENSIONS:	450 x 450 x 180 mm
CAPACITY:	25 l

AXS 101

Fire blanket bag

NEW

Capacity
120 litres

nr kat.: **AXS 101**



airtight roll-top closure



DIMENSIONS

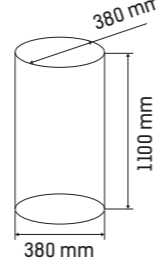

Technical data:

MATERIAL:	reinforced PVC
WEIGHT:	1890 g
DIMENSIONS:	1100 x 380 x 380 mm
CAPACITY:	120 l

Equipment:

- 1 chamber,
- tight rolling clasp.

AXS 300

Oblong cover for fire hose „M-42”

Ref no.: **AXS 300**



Available colors:

- YELLOW
AXS 300 01
- RED
AXS 300 02
- BLUE
AXS 300 03



Equipment:

- three straps with automatic buckles,
- two handles for transportation.

Technical data:

MATERIAL:	reinforced PVC
WEIGHT:	600 g
DIMENSIONS:	1200 x 600 mm

AXS 200

Fire hose cover “M-42”

Ref no.: **AXS 200**



Available colors:

- YELLOW
AXS 200 01
- RED
AXS 200 02
- BLUE
AXS 200 03

Equipment:

- four straps with automatic buckles.

Technical data:

MATERIAL:	reinforced PVC
WEIGHT:	950 g
DIMENSIONS:	800 x 610 mm

AX 016

Transport Bag

Capacity
75 litres

Ref no.: **AX 016**

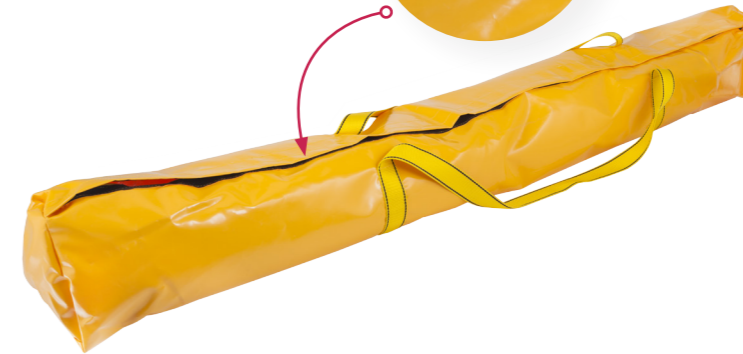
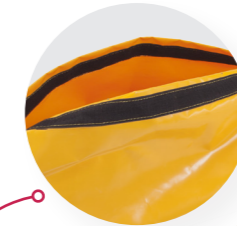

Available colors:

- YELLOW
AX 016 01
- RED
AX 016 02
- BLUE
AX 016 03

DIMENSIONS

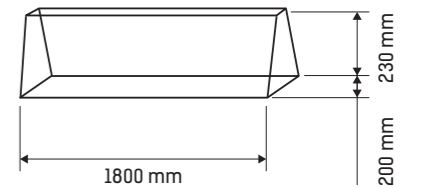

Equipment:

- two non-adjustable handles for carrying,
- velcro closures.

Technical data:

MATERIAL:	reinforced PVC
WEIGHT:	1250 g
DIMENSIONS:	1800 x 230 x 200 mm
CAPACITY:	75 l

AX 018

Transport Bag

Capacity
25 litres

Ref no.: **AX 018**



Available colors:

- YELLOW
AX 018 01
- RED
AX 018 02
- BLUE
AX 018 03

DIMENSIONS

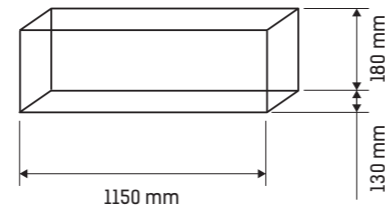

Technical data:

MATERIAL:	reinforced PVC
WEIGHT:	660 g
DIMENSIONS:	1150 x 130 x 180 mm
CAPACITY:	25 l

Equipment:

- two non-adjustable handles for carrying,
- zip closures.

AX 060

Transport Bag

Capacity
20 litres

Ref no.: **AX 060**



Available colors:

- YELLOW
AX 060 01
- RED
AX 060 02
- BLUE
AX 060 03

DIMENSIONS

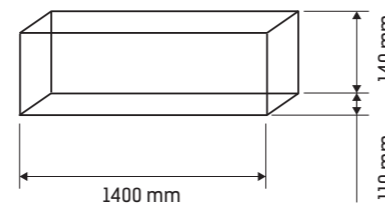

Technical data:

MATERIAL:	reinforced PVC
WEIGHT:	800 g
DIMENSIONS:	1400 x 110 x 140 mm
CAPACITY:	20 l

Equipment:

- two non-adjustable handles for carrying,
- zip closures,
- bottom reinforced with padding on both ends.



AX 700 80



AX 700 50



AX 700 30



AX 701 30



AX 701 15



AX 702 35



AX 702 25

Arborist baskets

AX 700 80

Arborist basket

Capacity
80 litres

Ref no.: **AX 700 80**



DIMENSIONS

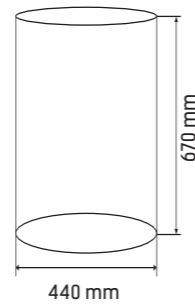

Equipment:

- shoulder strap,
- handle for horizontal carrying,
- two handles for carrying, the basket in hand,
- adjustable collar with a drawstring fastened with press studs.

Technical data:

MATERIAL:	textile tape / plastic
WEIGHT:	5280 g
DIMENSIONS:	670 x 440 x 345 mm
CAPACITY:	80 l

AX 700 50

Arborist basket

Capacity
50 litres

Ref no.: **AX 700 50**



DIMENSIONS

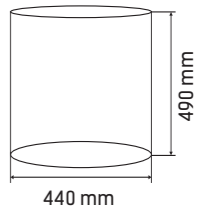

Equipment:

- shoulder strap,
- handle for horizontal carrying,
- two handles for carrying, the basket in hand,
- adjustable collar with a drawstring fastened with press studs.

Technical data:

MATERIAL:	textile tape / plastic
WEIGHT:	4320 g
DIMENSIONS:	490 x 440 x 345 mm
CAPACITY:	50 l

AX 700 30

Arborist basket

Capacity
30 litres

Ref no.: **AX 700 30**



DIMENSIONS

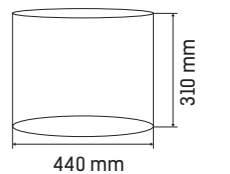

Equipment:

- shoulder strap,
- handle for horizontal carrying,
- two handles for carrying, the basket in hand,
- adjustable collar with a drawstring fastened with press studs.

Technical data:

MATERIAL:	textile tape / plastic
WEIGHT:	3000 g
DIMENSIONS:	310 x 440 x 345 mm
CAPACITY:	30 l

AX 701 30

Arborist basket

Capacity
30 litres

Ref no.: **AX 701 30**



Equipment:

- 3 types of carrying handles,
- 6 tool holders,
- adjustable collar with drawstring,
- transparent pocket,
- velcro fastened pockets,
- breathable material,
- plastic rigid bottom.

Technical data:

MATERIAL:	straps - polyester basket - fabric / PVC plawil bottom - plastic
WEIGHT:	940 g
WYMIARY:	430 x 300 x 300 mm
POJEMNOŚĆ:	30 l

AX 701 15

Arborist basket

Capacity
15 litres

Ref no.: **AX 701 15**



Equipment:

- 3 types of carrying handles,
- 6 tool holders,
- adjustable collar with drawstring,
- transparent pocket,
- breathable material,
- plastic rigid bottom.

Technical data:

MATERIAL:	straps - polyester basket - fabric / PVC plawil bottom - plastic
WEIGHT:	620 g
DIMENSIONS:	390 x 220 x 220 mm
CAPACITY:	15 l

AX 702 35

Arborist basket

NEW

Capacity
35 litres

Ref no.: **AX 702 30**



Equipment:

- external pocket,
- 2 holders inside for fastening,
- adjustable collar with drawstring,
- plastic rigid bottom.

Technical data:

MATERIAL:	straps - polyester PVC plawil bottom - plastic
WEIGHT:	1060 g
DIMENSIONS:	500 x 300 x 300 mm
CAPACITY:	35 l

AX 702 25

Arborist basket

NEW

Capacity
25 litres

Ref no.: **AX 702 25**



Equipment:

- external pocket,
- 2 holders inside for fastening,
- adjustable collar with drawstring,
- plastic rigid bottom.

Technical data:

MATERIAL:	straps - polyester PVC plawil bottom - plastic
WEIGHT:	960 g
DIMENSIONS:	380 x 300 x 300 mm
CAPACITY:	25 l



WX 003



WX 002



WX 001



WELDED
CONNECTING



WATER PROOF



LOW WEIGHT



WX 004



WX 005



WX 006



WX 007



WX 008



WX 009



WX 010

Dry Bags

WX 001

Dry Bag

Capacity
5 litres

Ref no.: **WX 001**



DIMENSIONS

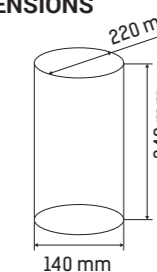

Available colours:

- YELLOW
WX 001 01
- RED
WX 001 02
- BLUE
WX 001 03

Transport bags made of material resistant to water and sun. Necessary equipment for sailors, canoeists as well as cyclists and motorcyclists.

Technical data:

MATERIAL:	bag - PVC tape - polyester
WEIGHT:	120 g
WYMIARY:	340 x 220 x 140 mm
CAPACITY:	5 l

WX 002

Dry Bag

Capacity
20 litres

Ref no.: **WX 002**



DIMENSIONS

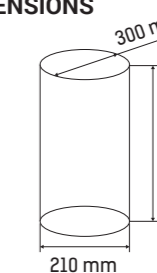

Available colours:

- YELLOW
WX 002 01
- RED
WX 002 02
- BLUE
WX 002 03

Transport bags made of material resistant to water and sun. Necessary equipment for sailors, canoeists as well as cyclists and motorcyclists.

Technical data:

MATERIAL:	bag - PVC tape - polyester
WEIGHT:	260 g
DIMENSIONS:	500 x 300 x 210 mm
CAPACITY:	20 l

Equipment:

- tight closurefastened with a buckle,
- comfortable adjustable strap
- to the carry the bag.

WX 003

Dry Bag

Capacity
35 litres

Ref no.: **WX 003**



DIMENSIONS

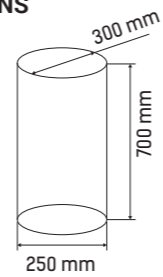

Available colours:

- YELLOW
WX 003 01
- RED
WX 003 02
- BLUE
WX 003 03

Transport bags made of material resistant to water and sun. Necessary equipment for sailors, canoeists as well as cyclists and motorcyclists.

Technical data:

MATERIAL:	bag - PVC tape - polyester
WEIGHT:	360 g
DIMENSIONS:	700 x 300 x 250 mm
CAPACITY:	35 l

Equipment:

- tight closurefastened with a buckle,
- comfortable adjustable strap
- to the carry the bag.

WX 004

Dry Bag

Capacity
20 litres

Ref no.: **WX 004**



DIMENSIONS

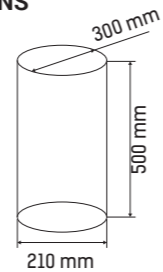

Available colours:

- YELLOW
WX 004 01
- RED
WX 004 02
- BLUE
WX 004 03

Transport bags made of material resistant to water and sun. Necessary equipment for sailors, canoeists as well as cyclists and motorcyclists.

Technical data:

MATERIAL:	bag - PVC tape - polyester
WEIGHT:	290 g
DIMENSIONS:	500 x300 x 210 mm
CAPACITY:	20 l

Equipment:

- tight closurefastened with a buckle,
- comfortable adjustable strap
- to the carry the bag.

WX 005

Dry Bag

Capacity
20 litres

Ref no.: **WX 005**



DIMENSIONS

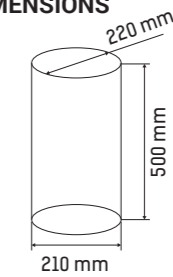

Available colours:

- YELLOW
WX 005 01
- RED
WX 005 02
- BLUE
WX 005 03

Transport bags made of material resistant to water and sun. Necessary equipment for sailors, canoeists as well as cyclists and motorcyclists.

Technical data:

MATERIAL:	bag - PVC tape - polyester
WEIGHT:	290 g
DIMENSIONS:	500 x 210 x 210 mm
CAPACITY:	20 l

Equipment:

- tight closurefastened with a buckle,
- comfortable adjustable strap
- to the carry the bag.

WX 006

Dry Bag

Capacity
35 litres

Ref no.: **WX 006**



DIMENSIONS

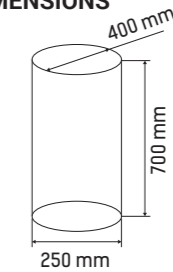

Available colours:

- YELLOW
WX 006 01
- RED
WX 006 02
- BLUE
WX 006 03

Transport bags made of material resistant to water and sun. Necessary equipment for sailors, canoeists as well as cyclists and motorcyclists.

Technical data:

MATERIAL:	bag - PVC tape - polyester
WEIGHT:	490 g
DIMENSIONS:	700 x 250 x250 mm
CAPACITY:	35 l

Equipment:

- tight closurefastened with a buckle,
- comfortable, adjustable shoulder straps.

WX 007

Dry Bag

Capacity
30 litres

Ref no.: **WX 007**



DIMENSIONS

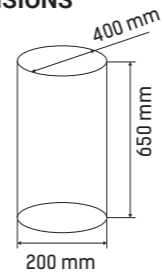

Available colours:

- YELLOW WX 007 01
- RED WX 007 02
- BLUE WX 007 03

Transport bags made of material resistant to water and sun. Necessary equipment for sailors, canoeists as well as cyclists and motorcyclists.

Technical data:

MATERIAL:	bag - PVC tape - polyester
WEIGHT:	500 g
DIMENSIONS:	650 x 200 x 200 mm
CAPACITY:	30 l

Equipment:

- tight closurefastened with a buckle,
- comfortable, adjustable shoulder straps.

WX 009

Dry Bag

Capacity
85 litres

Ref no.: **WX 009**



DIMENSIONS

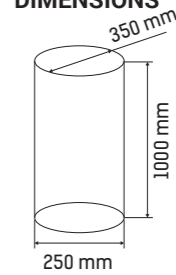

Available colours:

- YELLOW WX 009 01
- RED WX 009 02
- BLUE WX 009 03

Transport bags made of material resistant to water and sun. Necessary equipment for sailors, canoeists as well as cyclists and motorcyclists.

Technical data:

MATERIAL:	bag - PVC tape - polyester
WEIGHT:	905 g
DIMENSIONS:	1000 x 350 x 250 mm
CAPACITY:	85 l

Equipment:

- tight closurefastened with a buckle,
- comfortable, adjustable shoulder straps.

WX 008

Dry Bag

Capacity
20 litres

Ref no.: **WX 008**



DIMENSIONS

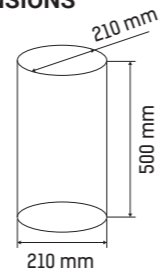

Available colours:

- YELLOW WX 008 01
- RED WX 008 02
- BLUE WX 008 03

Transport bags made of material resistant to water and sun. Necessary equipment for sailors, canoeists as well as cyclists and motorcyclists.

Technical data:

MATERIAL:	bag - PVC tape - polyester
WEIGHT:	320 g
DIMENSIONS:	500 x 210 x 210 mm
CAPACITY:	20 l

Equipment:

- tight closurefastened with a buckle,
- comfortable adjustable strap to the carry the bag.

WX 010

Dry Bag

Capacity
85 litres

Ref no.: **WX 010**



DIMENSIONS

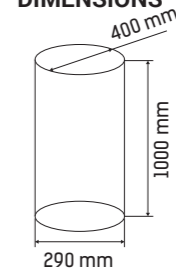

Available colours:

- YELLOW WX 010 01
- RED WX 010 02
- BLUE WX 010 03

Transport bags made of material resistant to water and sun. Necessary equipment for sailors, canoeists as well as cyclists and motorcyclists.

Technical data:

MATERIAL:	bag - PVC tape - polyester
WEIGHT:	825 g
DIMENSIONS:	1000 x 290 x 290 mm
CAPACITY:	85 l

Equipment:

- tight closurefastened with a buckle,
- comfortable, adjustable shoulder straps.

TOOL LINKS HOLDERS BAGS

according to ANSI/ISEA 121-2018



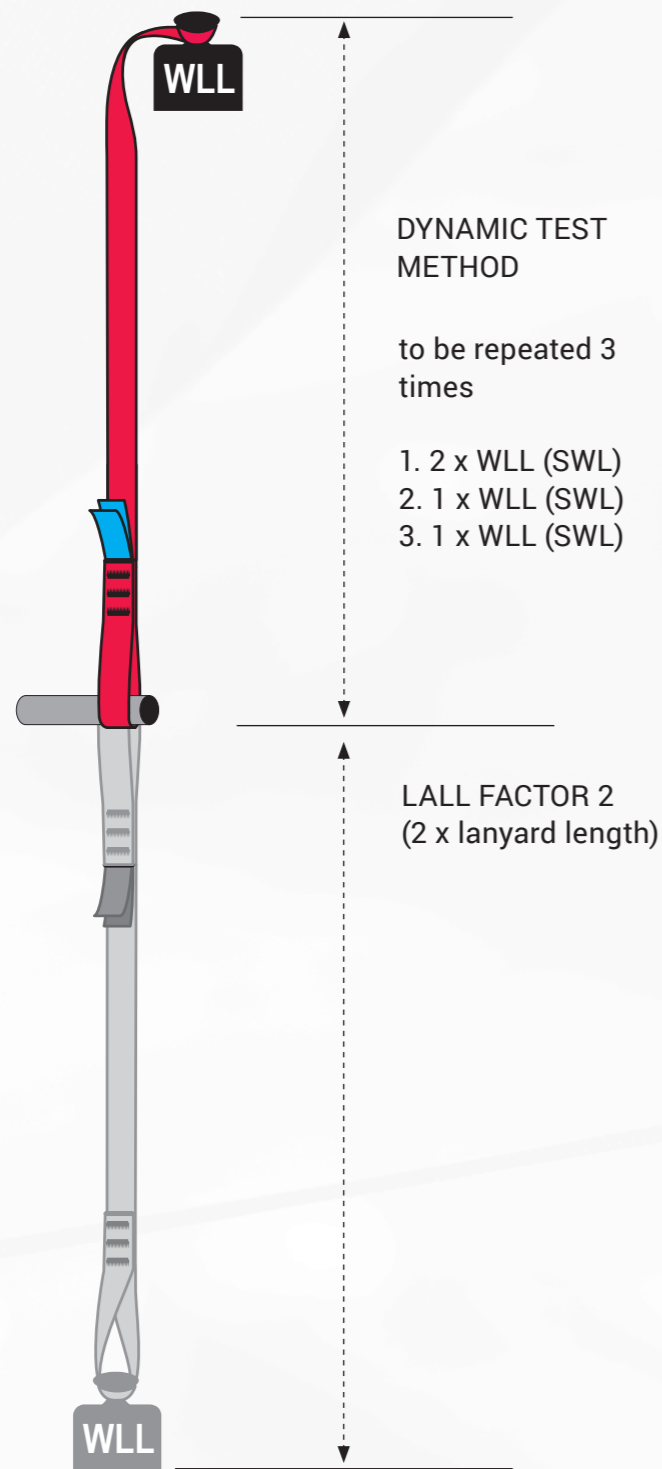

ANSI/ISEA 121-2018 Important sections of standard in question:

American National Standard for Dropped Object Prevention Solutions.

This standard establishes minimum design, performance, testing and labelling requirements for solutions that reduce dropped objects incidents in industrial and occupational settings. Dropped objects include hand tools, instrumentation, small parts, structural components and other items that have to be transferred and used at heights. These objects have the opportunity of becoming dropped objects potentially resulting in struck-by injury or fatality or damage to equipment.

5.3.2 Test Equipment

The test equipment shall consist of the following:

- a) Tool attachment sample.
- b) Test cable of fabricated steel with swaged looped ends measuring a minimum of twice the length of the manufacturer's allowable maximum tether length for the tool attachment, plus 60cm.
- c) A rigid weight, weighing a total of the specified test factor listed in test schedule.
- d) A test fixture designed and built accordingly to allow installation onto the fixed anchor point.

If a specific tool size range or geometry is detailed for use with the tool attachment, the test weight or test fixture shall mimic that tool's characteristics.

5.3.3 Dynamic Test Procedure

Each test sample that requires a dynamic test shall be subjected to a minimum of 3 drops without replacement or adjustment of the sample. Each test sample shall be tested within 5 minutes of removal from conditioning. If testing cannot be completed within the allotted time, samples shall be reconditioned between drops.

One of the following methods shall be used:

- a) Attach one end of the test cable to the connection point on the tool attachment and the other end to the fixed anchor point. The test weight shall be positioned in a way to expose the weakest orientation of the tool attachment.

- b) Install test fixture onto fixed anchor point. Attach the tool attachment to the test fixture in a position that exposes the weakest orientation of the tool attachment. Attach one end of the test cable to the tool attachment and the other end to an independent test weight.

Perform a drop with a test weight equal to the manufacturer's published capacity with a free fall distance of twice the specified test tether length allowed by the manufacturer. The test weight shall be released from a point no more than 152 mm horizontally from the centre of the fixed anchor point. The test weight shall be orientated in a way that allows the weight to experience a straight fall. Follow this procedure for two additional drops. A total of three drops shall be recorded. (Refer to figure.)



AY 010

Retractable tool lanyard with lock



tested in accordance with ANSI/ISEA 121-2018
2 kg

Ref no.: AY010

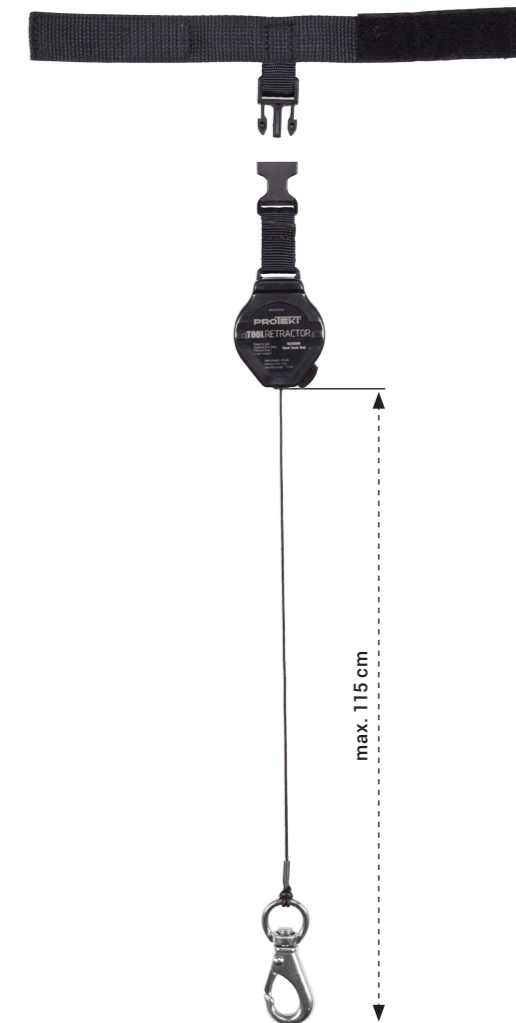

AY 010



AY 003



AY 013



CARABINER WITH SWIVEL SHACKLE
opening \varnothing 10 mm

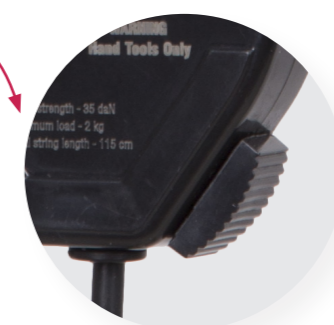

LANYARD LOCK

Retractable lanyard with lock and strap for wrapping around a wrist using Velcro fastener.

Technical data:

Material of lanyard:	polyester
Maximum load:	2 kg
Lanyard length:	max.115 cm
Lanyard length:	35 daN

Retractable tool lanyards

AY 003

Retractable tool lanyard



tested in accordance
with ANSI/ISEA 121-2018
2 kg

Ref no.: **AY 003**



CARABINER WITH SWIVEL SHACKLE
opening ϕ 10 mm

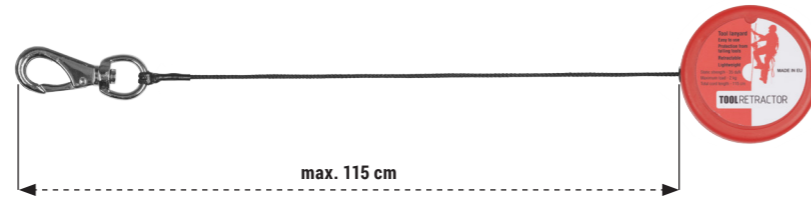

Retractable lanyard protecting against dropping of tools.

Technical data:

Material of lanyard:	polyester
Maximum load:	2 kg
Lanyard length:	max.115 cm
Lanyard length:	35 daN



AY 013

Retractable tool lanyard



tested in accordance
with ANSI/ISEA 121-2018
2 kg

Ref no.: **AY 013**



CARABINER WITH SWIVEL SHACKLE
opening ϕ 10 mm

CLIP

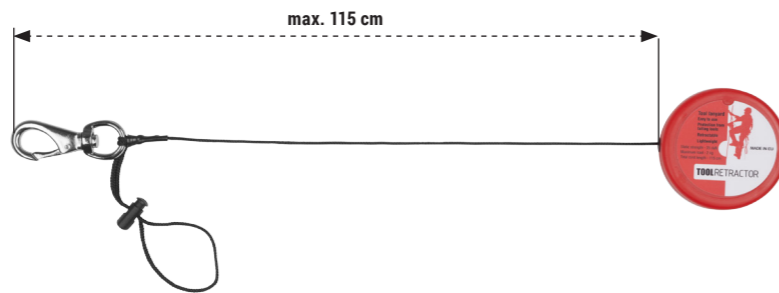

Retractable lanyard protecting against dropping of tools additionally equipped with string and clip for adjustment.

Technical data:

Material of lanyard:	polyester
Maximum load:	2 kg
Lanyard length:	max.115 cm
Lanyard length:	35 daN

AY 023

AY 040/BT 001

AY 040/BT 002

AY 040/BT 003

AY 040/BT 004

AY 040/BT 005

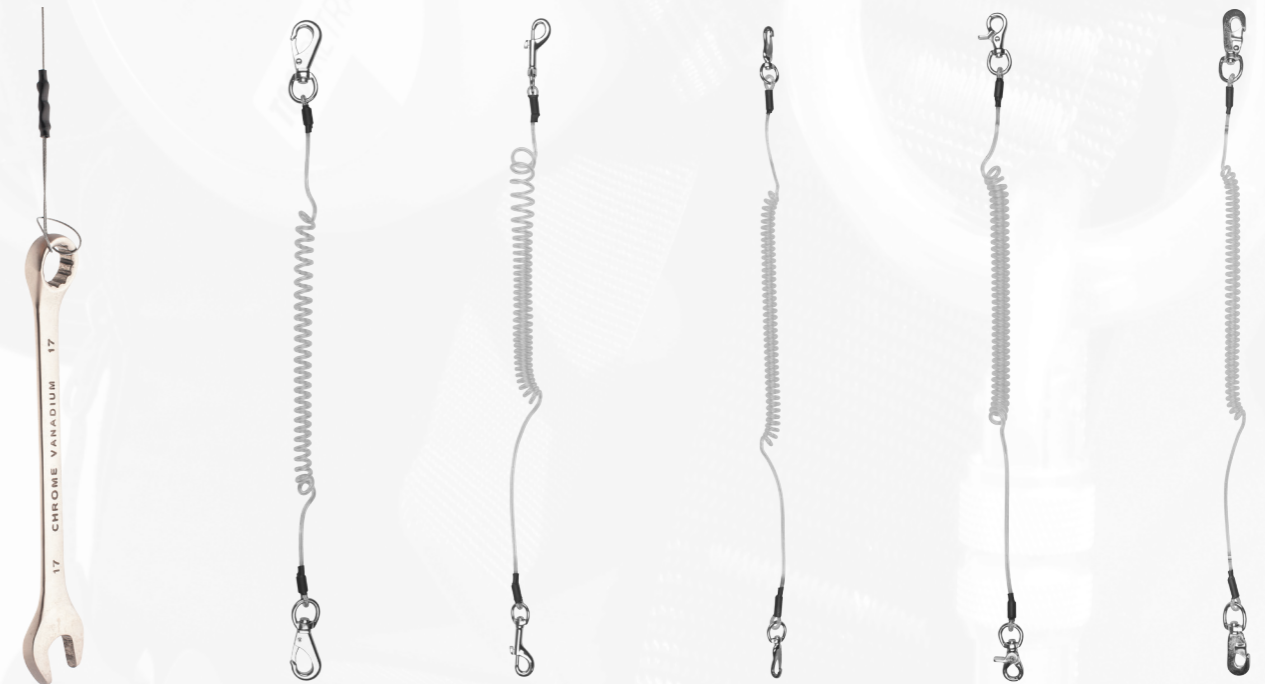

Steel tool lanyards

AY 023

Steel tool lanyard



tested in accordance
with ANSI/ISEA 121-2018
2 kg

Ref no.: **AY 023**

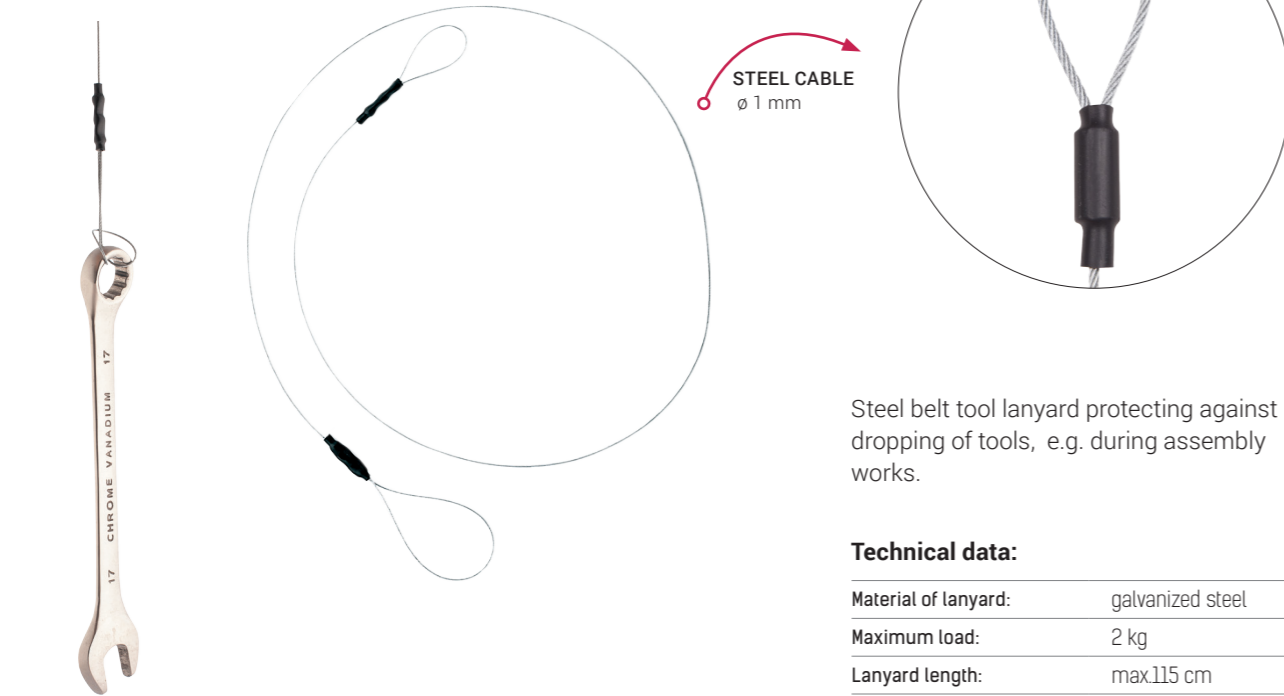

Steel belt tool lanyard protecting against dropping of tools, e.g. during assembly works.

Technical data:

Material of lanyard:	galvanized steel
Maximum load:	2 kg
Lanyard length:	max.115 cm

AY 040 / BT 001

Steel tool lanyard



tested in accordance
with ANSI/ISEA 121-2018
2 kg

Ref no.: **AY 040 / BT 001**

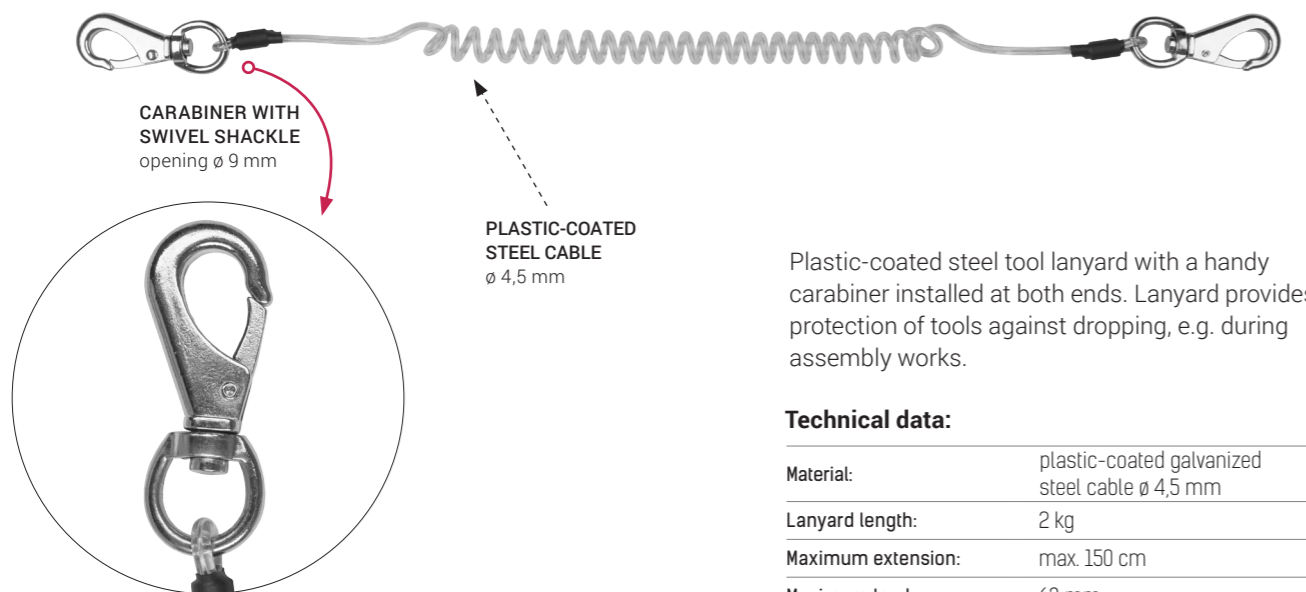

Plastic-coated steel tool lanyard with a handy carabiner installed at both ends. Lanyard provides protection of tools against dropping, e.g. during assembly works.

Technical data:

Material:	plastic-coated galvanized steel cable \varnothing 4,5 mm
Lanyard length:	2 kg
Maximum extension:	max. 150 cm
Maximum load:	63 mm

AY 040 / BT 002

Steel tool lanyard



tested in accordance
with ANSI/ISEA 121-2018
2 kg

Ref no.: **AY 040 / BT 002**

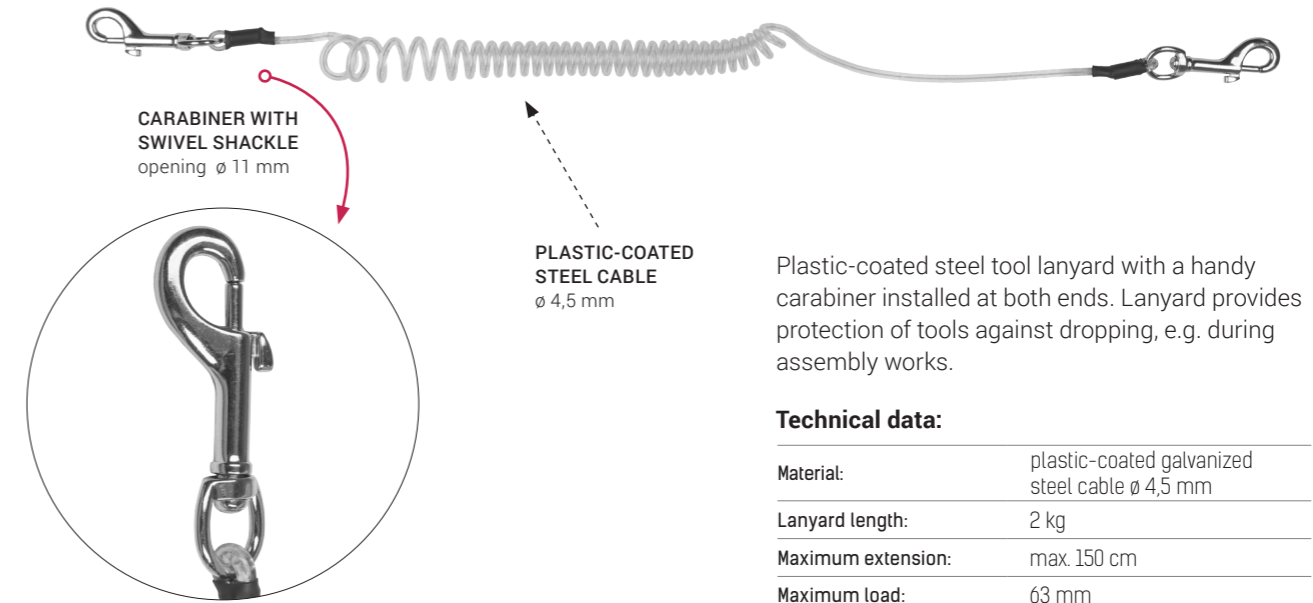

Plastic-coated steel tool lanyard with a handy carabiner installed at both ends. Lanyard provides protection of tools against dropping, e.g. during assembly works.

Technical data:

Material:	plastic-coated galvanized steel cable \varnothing 4,5 mm
Lanyard length:	2 kg
Maximum extension:	max. 150 cm
Maximum load:	63 mm

AY 040 / BT 003

Steel tool lanyard



tested in accordance
with ANSI/ISEA 121-2018
2 kg

Ref no.: **AY 040 / BT 003**

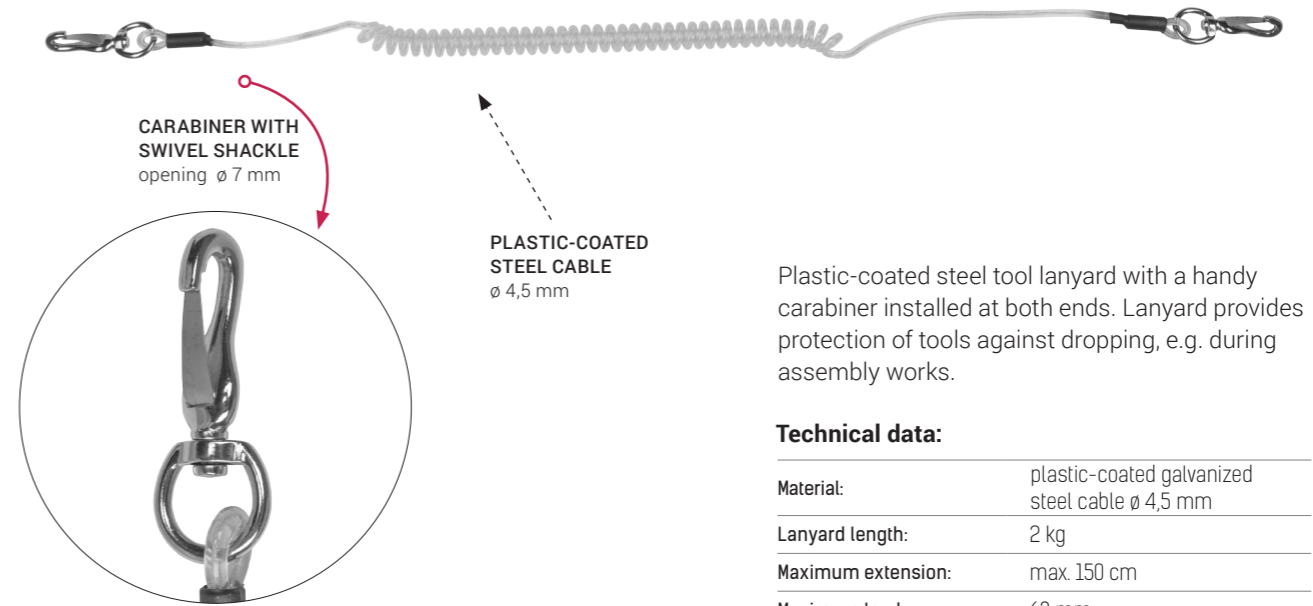

Plastic-coated steel tool lanyard with a handy carabiner installed at both ends. Lanyard provides protection of tools against dropping, e.g. during assembly works.

Technical data:

Material:	plastic-coated galvanized steel cable \varnothing 4,5 mm
Lanyard length:	2 kg
Maximum extension:	max. 150 cm
Maximum load:	63 mm

AY 040 / BT 004

Steel tool lanyard



tested in accordance with ANSI/ISEA 121-2018
2 kg

Ref no.: **AY 040 / BT 004**

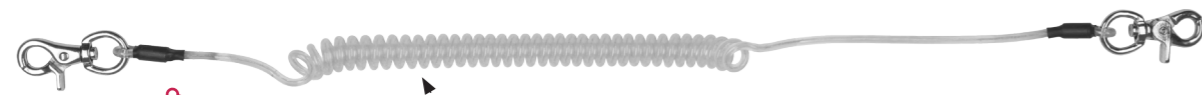

CARABINER WITH SWIVEL SHACKLE
opening \varnothing 14 mm

PLASTIC-COATED STEEL CABLE
 \varnothing 4,5 mm



Plastic-coated steel tool lanyard with a handy carabiner installed at both ends. Lanyard provides protection of tools against dropping, e.g. during assembly works..

Technical data:

Material:	plastic-coated galvanized steel cable \varnothing 4,5 mm
Lanyard length:	2 kg
Maximum extension:	max. 150 cm
Maximum load:	63 mm

AY 040 / BT 005

Steel tool lanyard



tested in accordance with ANSI/ISEA 121-2018
2 kg

Ref no.: **AY 040 / BT 005**



CARABINER WITH SWIVEL SHACKLE
opening \varnothing 10 mm

PLASTIC-COATED STEEL CABLE
 \varnothing 4,5 mm



Plastic-coated steel tool lanyard with a handy carabiner installed at both ends. Lanyard provides protection of tools against dropping, e.g. during assembly works.

Technical data:

Material:	plastic-coated galvanized steel cable \varnothing 4,5 mm
Lanyard length:	2 kg
Maximum extension:	max. 150 cm
Maximum load:	63 mm



AY 051

AY 052

AY 023

AY 054

AY 057



AY 058

AY 059

AY 060

AY 055

AY 132

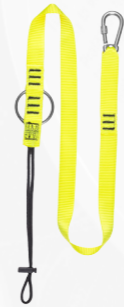

AY 133

AY 135

AY 153



Tool bags and belts

AY 001

Wrist tool lanyard



tested in accordance with ANSI/ISEA 121-2018
1 kg

Ref no.: **AY 001**

Ref no.:

BAND WITH VELCRO



CLIP

Wrist lanyard protecting against dropping of tools equipped with string and clip for adjustment. Wrapped around wrist using band with Velcro fastener.

Technical data:

Material:	polyester
Maximum load:	1 kg

AY 002

Elastic belt tool lanyard



tested in accordance with ANSI/ISEA 121-2018
1 kg

Ref no.: **AY 002**

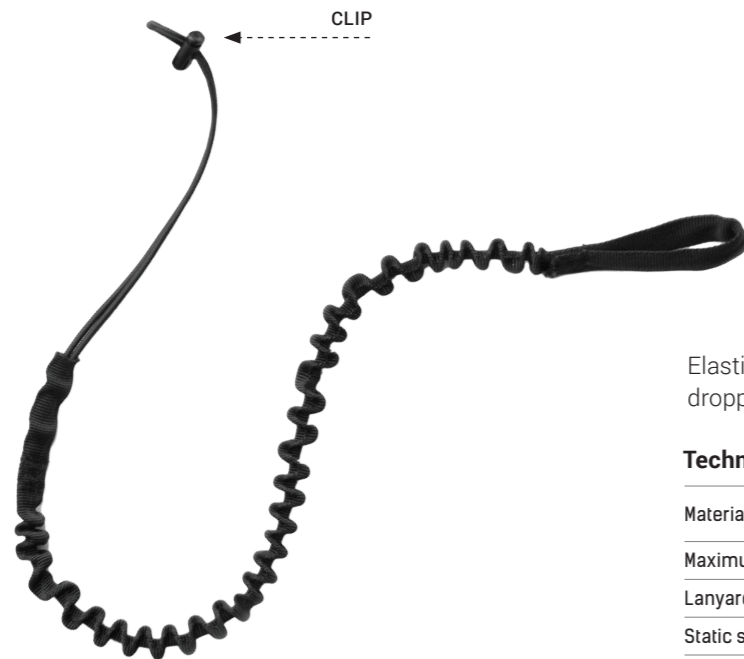

CLIP

Elastic belt tool lanyard protecting against dropping of tools with clip for adjustment.

Technical data:

Material:	polyester
Maximum load:	1 kg
Lanyard length:	max. 120 cm
Static strength:	15 daN / 3 min. without failure

AY 011

Wrist tool lanyard



tested in accordance with ANSI/ISEA 121-2018
1 kg

Ref no.: **AY 011**



BAND WITH VELCRO

CLIP

Wrist lanyard protecting against dropping of tools equipped with string and clip for adjustment. Wrapped around wrist using band with Velcro fastener.

Technical data:

Material:	polyester
Maximum load:	1 kg

AY 012

Elastic belt tool lanyard for left-handed users



tested in accordance with ANSI/ISEA 121-2018
0,5 kg

Ref no.: **AY 012**



BAND WITH VELCRO

CLIP

ELASTIC LANYARD

Elastic belt tool lanyard protecting against dropping of tools with clip for adjustment designed for left-handed users.

Technical data:

Material link:	polyester
Maximum load:	0,5 kg
Maximum load:	max. 115 cm
Static strength:	35daN / 3 min. without failure

AY 022

Tool lanyard



tested in accordance with ANSI/ISEA 121-2018
0,25 kg

Ref no.: AY 022

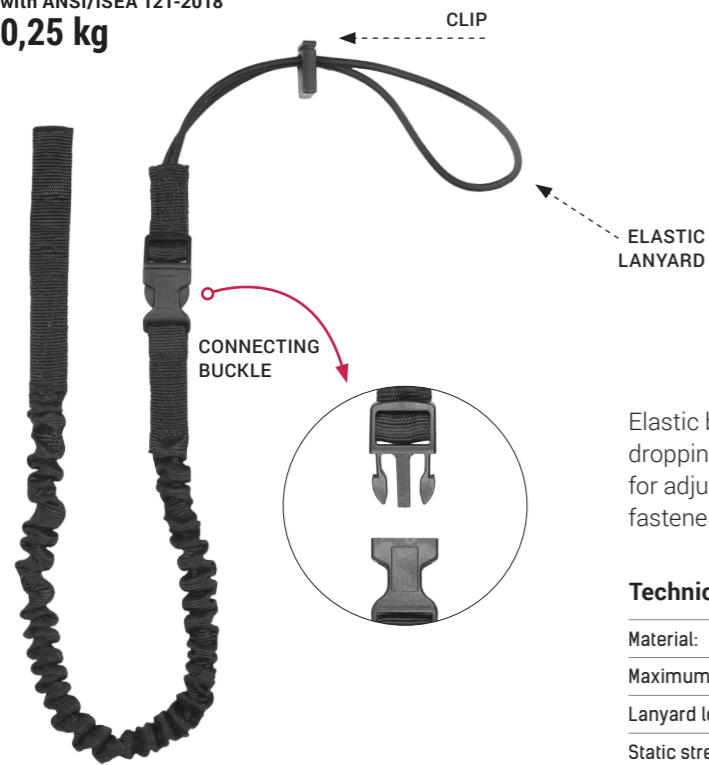

Elastic belt tool lanyard protecting against dropping of tools. Equipped with a string and clip for adjustment and connecting buckle with Velcro fastener.

Technical data:

Material:	polyester
Maximum load:	0,25 kg
Lanyard length:	max. 150 cm
Static strength:	35 daN / 3 min. without failure

AY 051

Tool lanyard



tested in accordance with ANSI/ISEA 121-2018
4 kg

Ref no.: AY 051

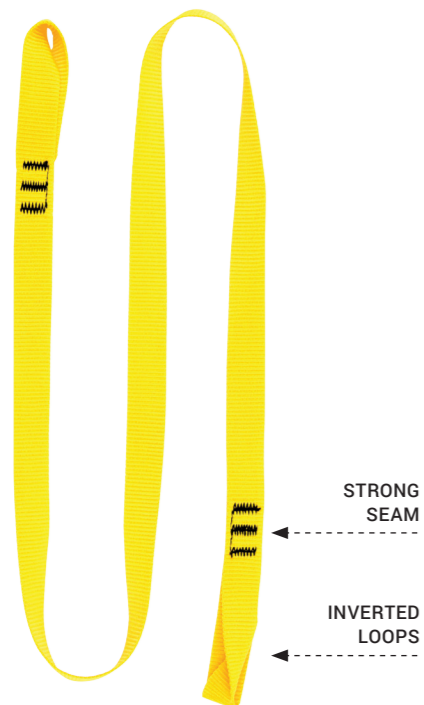

Tool lanyard – protection against dropping of tools, e.g. chainsaw. Strong seams, inverted loops – always open.

Technical data:

Material:	polyester
Webbing width:	25 mm
Length:	13 m
Static strength:	5 kN
Maximum load:	4 kg
Safety Factor:	7:1

AY 052

Tool lanyard



tested in accordance with ANSI/ISEA 121-2018
4 kg

Ref no.: AY 052

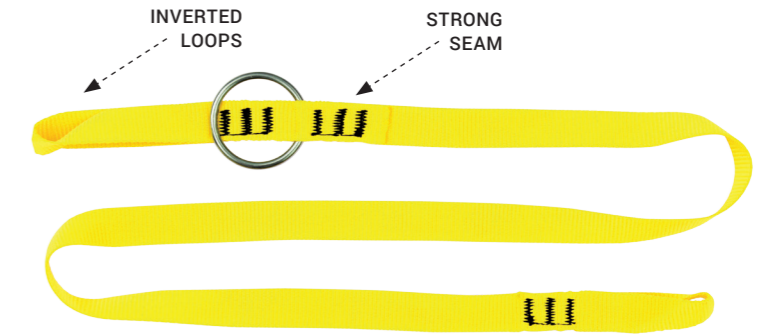

Protection against dropping of tools, e.g. chainsaw or other accessories. Strong seams, handy inverted loops.

Technical data:

Material:	polyester
Webbing width:	25 mm
Length:	13 m
Static strength:	5 kN
Maximum load:	4 kg
Safety Factor:	7:1

AY 053

Tool lanyard



tested in accordance with ANSI/ISEA 121-2018
4 kg

Ref no.: AY 053

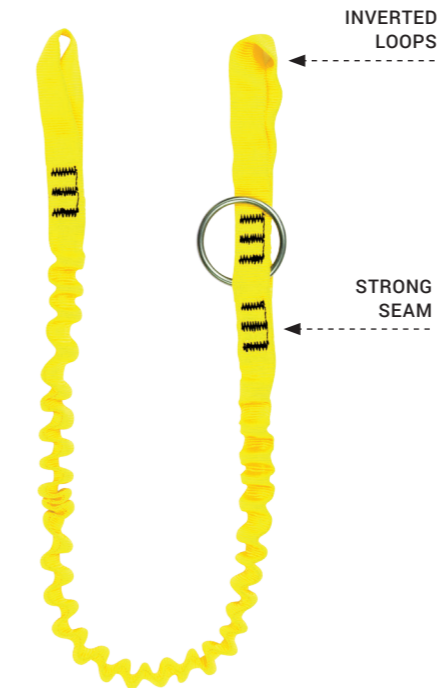

Tool lanyard – protection against dropping of tools, e.g. chainsaw. Strong seams, handy inverted loops.

Technical data:

Material:	polyester
Webbing width:	25 mm
Length:	13 m
Static strength:	5 kN
Maximum load:	4 kg
Safety Factor:	7:1

AY 054

Tool lanyard



tested in accordance
with ANSI/ISEA 121-2018
5 kg

Ref no.: **AY 054**

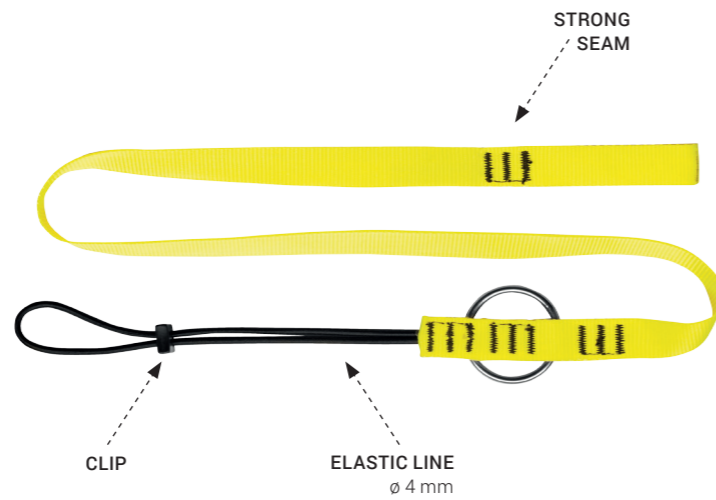

Technical data:

Material:	polyester
Webbing width:	25 mm
Length:	1.3 m
Static strength:	600 N
Maximum load:	5 kg
Safety Factor:	7:1

Tool lanyard – protection against dropping of tools, e.g. assembly wrenches. Strong seams, equipped with elastic line at one end.

AY 057

Tool lanyard



tested in accordance
with ANSI/ISEA 121-2018
5 kg

Ref no.: **AY 057**



Technical data:

Material:	webbing - polyester carabiner - steel
Webbing width:	25 mm
Length:	1.3 m
Static strength:	600 N
Maximum load:	5 kg
Safety Factor:	7:1

Tool lanyard – protection against dropping of tools, e.g. assembly wrenches. Strong seams, equipped with elastic line at one end, and steel detachable carabiner with opening of 10 mm at the other.

AY 058

Tool lanyard



tested in accordance
with ANSI/ISEA 121-2018
5 kg

Ref no.: **AY 058**



Technical data:

Material:	webbing - polyester carabiner - steel
Webbing width:	25 mm
Length:	1.3 m
Static strength:	600 N
Maximum load:	5 kg
Safety Factor:	7:1

Tool lanyard – protection against dropping of tools, e.g. assembly wrenches. Strong seams, equipped with elastic line at one end, and steel detachable carabiner with opening of 7 mm at the other.

AY 059

Tool lanyard



tested in accordance
with ANSI/ISEA 121-2018
5 kg

Ref no.: **AY 059**



Technical data:

Material:	webbing - polyester carabiner - stainless steel
Webbing width:	25 mm
Length:	1.3 m
Static strength:	600 N
Maximum load:	5 kg
Safety Factor:	7:1

Tool lanyard – protection against dropping of tools, e.g. assembly wrenches. Strong seams, equipped with elastic line at one end, and stainless-steel detachable carabiner with opening of 7 mm at the other.

AY 060

Tool lanyard



tested in accordance with ANSI/ISEA 121-2018
3 kg

Ref no.: **AY 060**

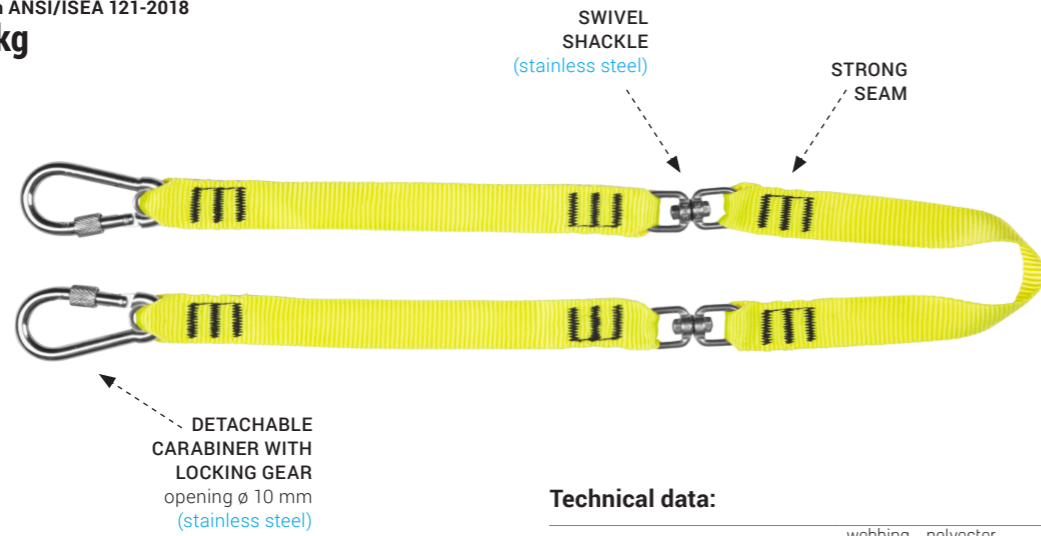

Technical data:

Material:	webbing - polyester carabiner / swivel shackles - stainless steel
Webbing width:	25 mm
Length:	1.3 m
Static strength:	600 N
Maximum load:	3 kg
Safety Factor:	7:1

Tool lanyard connected by two swivel shackles (enabling 360° rotation) – protection against dropping of tools, e.g. assembly wrenches. Strong seams, equipped with stainless-steel carabiners with opening of 10 mm at both ends.

AY 055

Tool lanyard



tested in accordance with ANSI/ISEA 121-2018
30 kg

Ref no.: **AY 055**

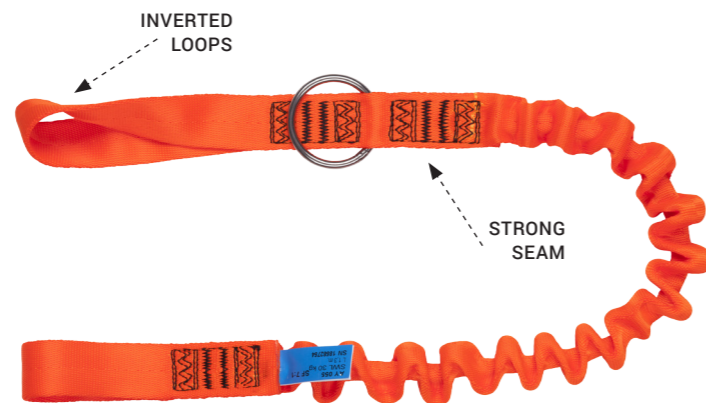

Technical data:

Material:	polyester
Webbing width:	25 mm
Length:	1.3 m
Static strength:	5 kN
Maximum load:	30 kg
Safety Factor:	7:1

Elastic tool lanyard – protection against dropping of tools, e.g. power screwdriver or chainsaw. Strong seams, handy inverted loop.

AY 132

Tool lanyard



tested in accordance with ANSI/ISEA 121-2018
0,5 kg

Ref no.: **AY 132**



Elastic tool lanyard with carabiner. Protection against dropping of tools, e.g. assembly wrenches.

Technical data:

Material:	polyester
Webbing width:	64 cm
Maximum extension:	max. 125 cm
Maximum load:	0,5 kg

AY 133

Tool lanyard



tested in accordance with ANSI/ISEA 121-2018
1 kg

Ref no.: **AY 133**



Elastic belt tool lanyard with carabiner. Protection against dropping of tools, e.g. assembly wrenches.

Technical data:

Material:	polyester
Webbing width:	64 cm
Maximum extension:	max. 125 cm
Maximum load:	1 kg

AY 135

Tool lanyard



tested in accordance
with ANSI/ISEA 121-2018
0,5 kg

Ref no.: **AY 135**

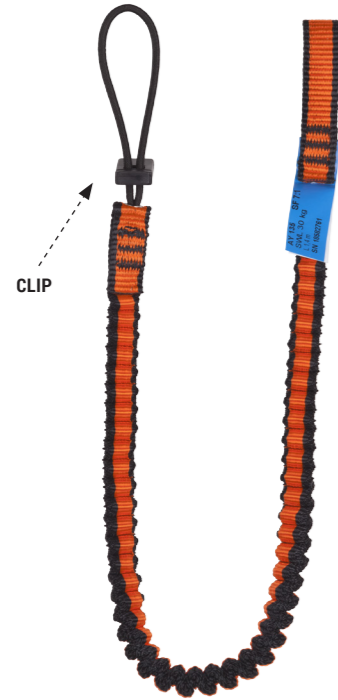

Elastic tool lanyard – protection against dropping of tools, e.g. assembly wrenches.

Technical data:

Material:	polyester
Webbing width:	64 cm
Maximum extension:	max. 125 cm
Maximum load:	0,5 kg



AY 153

Tool lanyard



tested in accordance
with ANSI/ISEA 121-2018
15 kg

Ref no.: **AY 153**



Elastic tool lanyard with handy inverted loop. Protection against dropping of tools, e.g. assembly wrenches.

Technical data:

Material:	polyester
Webbing width:	64 cm
Maximum extension:	max. 125 cm
Maximum load:	15 kg

AY 300



AY 301



AY 302



AY 303



AY 061

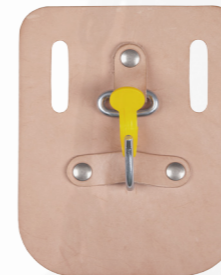

AY 100



AY 305



AY 306



AY 307



Tool holders

AY 300

Tool holder



tested in accordance
with ANSI/ISEA 121-2018
2 kg

Ref no.: **AY 300**



AY 300 is a webbing tool holder fixed using Velcro fastener to a belt or straps of harnesses or full body harnesses. Provides optimum arrangement of tools which in turn improves working comfort. AY 300 enables connection of e.g. tool lanyard.

Technical data:

Material:	polyester webbing plastic holder
Webbing width:	40 mm
Max. load:	2 kg

AY 301

Tool holder



tested in accordance
with ANSI/ISEA 121-2018
2 kg

Ref no.: **AY 301**



AY 301 is a webbing tool holder fixed using Velcro fastener to a belt or straps of harnesses or full body harnesses. Provides optimum arrangement of tools which in turn improves working comfort. AY 301 enables connection of e.g. tool lanyard.

Technical data:

Material:	polyester webbing steel holder
Webbing width:	40 mm
Max. load:	2 kg

AY 302

Tool holder



tested in accordance
with ANSI/ISEA 121-2018
2 kg

Ref no.: **AY 302**



AY 302 is a webbing tool holder fixed using Velcro fastener to a belt or straps of harnesses or full body harnesses. Provides optimum arrangement of tools which in turn improves working comfort. AY 302 enables connection of e.g. tool lanyard.

Technical data:

Material:	polyester webbing plastic holder
Webbing width:	40 mm
Max. load:	2 kg

AY 303

Tool holder



tested in accordance
with ANSI/ISEA 121-2018
2 kg

Ref no.: **AY 303**



AY 303 is a webbing tool holder fixed using Velcro fastener to a belt or straps of harnesses or full body harnesses. Provides optimum arrangement of tools which in turn improves working comfort. AY 303 enables connection of e.g. tool lanyard.

Technical data:

Material:	polyester webbing steel holder
Webbing width:	40 mm
Max. load:	2 kg

AY 061

Tool holder

Ref no.: **AY 061**

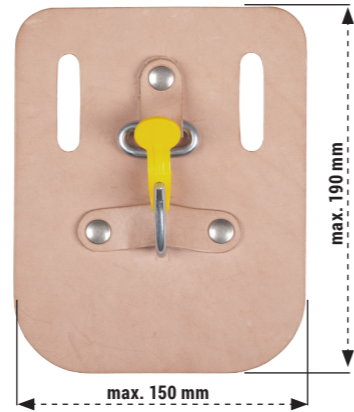

Tool holder for fixing to a belt at a harness, with webbing width from 40 to 50 mm.

Technical data:

Harness webbing width:	40-50 mm
Material:	leather
Dimensions:	150 x 190 mm
Weight:	126 g

AY 100

Tool holder

Ref no.: **AY 100**



AY 100 is a carabiner used as a tool holder, attached to straps of a harness or a full body harness to provide optimum arrangement of tools and in turn improve working comfort. AY 100 enables connection of tool lanyard also.

Note!
AY 100 is not personal fall protection equipment.

Technical data:

Weight:	25 g
Dimensions:	108 x 54 x 14 mm
Working Load Limit (WLL):	5 kg
Material:	polyamide, glass fibre, stainless steel
Breaking strength:	> 25 kg

AY 305

Electric screwdriver handle

Ref no.: **AY 305**



The AY 305 is an ergonomic handle used to prevent screwdrivers and similar tools from falling. Thanks to the steel clip, it can be attached to a tool belt with a lanyard.

Technical data:

Material:	polyester / clip - steel
Weight:	110 g
Tape width:	40 mm

AY 306

Handle measuring roll tape
3m / 5m

Ref no.: AY 306



AY 306 are new ergonomic handle measuring roll tape 3m/5m with Velcro fasteners. Thanks to the steel hitch we have the possibility of fixing e.g. to the tool belt.

Technical data:

Material:	polyester / clip - steel
Weight:	30 g
Tape width:	25 mm / 30 mm

AY 307

Handle measuring roll tape
5m / 10m

Ref no.: AY 307



AY 307 are new ergonomic handle measuring roll tape 5m/10m with Velcro fasteners. Thanks to the steel hitch we have the possibility of fixing e.g. to the tool belt.

Technical data:

Material:	polyester / clip - steel
Weight:	35 g
Tape width:	25 mm / 30 mm

AY 200



AY 210



AY 220



TA 307



TA 305



TA 304



TA 310



TA 308



TA 309



TA 311



TA 312



TA 313



TA 320



TA 321



Tool bags and belts

AY 200

Hip tool belt

Ref no.: **AY 200**

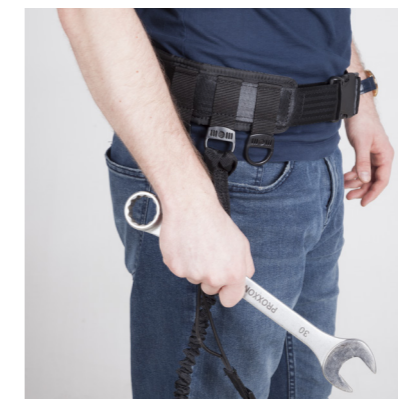

Hip tool belt fastened with Velcro fastener. Provides optimum arrangement of tools which in turn improves working comfort. AY 200 enables connection of e.g. tool lanyards.

Technical data:

Belt webbing width:	70 mm
Material:	poliester
Weight:	251 g

AY 210

Hip tool belt

nr kat.: **AY 210**



Hip tool belt fastened using connecting and adjusting buckle. Provides optimum arrangement and handling of tools which in turn improves working comfort.

Technical data:

Material:	polyester
Weight:	420 g
Belt webbing width:	40 mm

AY 220

Hip tool belt

Ref no.: AY 220

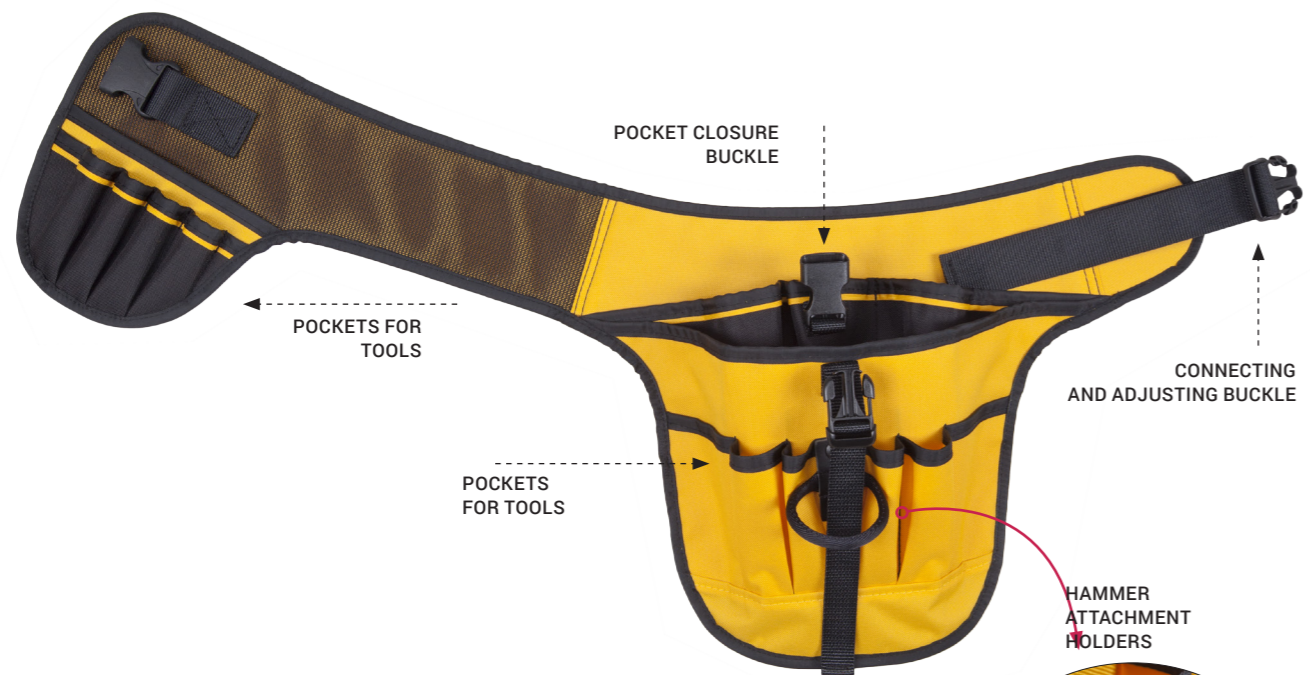

Hip tool belt fastened using connecting and adjusting buckle. Provides optimum arrangement and handling of tools which in turn improves working comfort.

Technical data:

Belt webbing width:	40 mm
Material:	polyester
Weight:	560 g

TA 307

Tool bag

Ref no.: TA 307



**REINFORCED
BOTTOM
OF THE BAG!**



ATTACHMENT BUCKLE OF THE ADJUSTABLE SHOULDER STRAP



STIFFENED THE EDGES OF THE BAG



A large and comfortable bag with a reinforced bottom for carrying fitter's accessories made of durable Cordura. It has stiffened edges, which makes loading of tools easier. The bag also has an adjustable strap, so you can hang it over your shoulder.

Technical data:

Weight:	1,35 kg
Dimensions:	560 x 280 x 260 mm
Material:	polyester

TA 305

Handy tool bag

Ref no.: TA 305

FUNCTIONAL AND ERGONOMIC ARRANGEMENT OF TOOLS!



Handy tool bag for handling of assembly accessories, made of strong polyester. It has multiple pockets and compartments inside to ensure tools are in place. The bag has an adjustable strap for comfortable carrying on shoulder.

Technical data:

Weight:	1,0 kg
Dimensions:	375 x 260 x 90 mm
Material:	polyester

TA 304

Large tool bag

Ref no.: TA 304

LARGE CAPACITY AND STRENGTH!



Large and handy bag for handling of assembly accessories, made of strong polyester. It is equipped with multiple pockets and compartments both inside and outside to provide optimum arrangement of tools. The bag has an adjustable strap for comfortable carrying on shoulder.

Technical data:

Weight:	2,4 kg
Dimensions:	500 x 300 x 300 mm
Material:	polyester

TA 308

Tool basket

Capacity

17 liters

Ref no.: **TA 308**

LITTLE BASKET WITH QUICK ACCESS TO DO TOOLS!



DURABLE FABRIC COVER



STRONG PLASTIC

Ø 210mm

Convenient tool basket for assembly work made of durable fabric. It has many pockets and compartments inside for easy organization of tools. The basket also has an adjustable strap, so you can hang it over your shoulder.

Technical data:

Weight:	0,98 kg
Dimensions:	270 x 270 x 210 mm
Material:	v
Capacity:	17 L

TA 309

Tool basket

Capacity

27 liters

Ref no.: **TA 309**

BIG BASKET WITH QUICK ACCESS TO DO TOOLS!



DURABLE FABRIC COVER

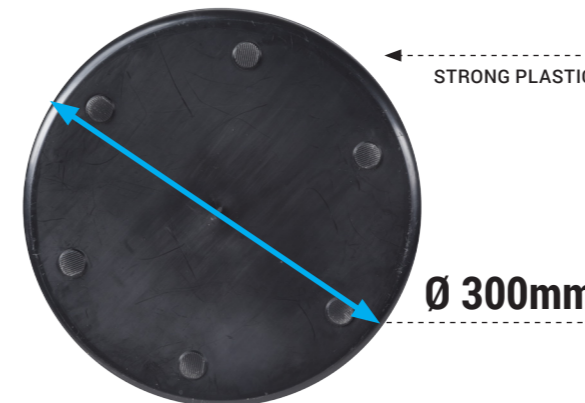

STRONG PLASTIC

Ø 300mm

Large tool basket for assembly work made of durable fabric. It has many pockets and compartments inside for easy organization of tools. The basket also has an adjustable strap, so you can hang it over your shoulder.

Technical data:

Weight:	1,5 kg
Dimensions:	300 x 300 x 310 mm
Material:	fabric
Capacity:	27 L

TA 310

Tool bag on wheels

Capacity
17 liters

Ref no.: **TA 310**

**HIGH PACKING
CAPACITY
AND PRACTICAL
ARRANGEMENT
TOOLS!**



Large and comfortable bag with wheels for transporting assembly accessories with a stiffening inside. Made of durable polyester. It has compartments inside and outside pockets, which makes it easier to organize tools properly. It is also equipped with a retractable telescopic handle, allowing for smooth movement.

Technical data:

Weight:	0,98 kg
Dimensions:	270 x 270 x 210 mm
Material:	fabric
Capacity:	17 L

TA 311

Tool bag attached to the belt

Capacity
2,7 liters

Ref no.: **TA 311**



Small tool bag attached to the belt. Useful when performing any assembly work, etc. It has a collar with a welt, for quick access to tools.

Technical data:

Weight:	280 g
Dimensions:	160 x 160 x 310 mm
Material:	PCV
Capacity:	2,7 L

TA 312

Tool bag attached to the belt

Capacity
9 liters

Ref no.: **TA 312**



Tool trolley fastened to the belt with a convenient zipper closure. Useful when performing any assembly work, etc. It has numerous tool holders and an internal mesh pocket.

Technical data:

Weight:	340 g
Dimensions:	180 x 180 x 300 mm
Material:	PCW
Capacity:	9 L

TA 313

Tool bag attached to the belt

Capacity
17 liters

Ref no.: **TA 313**



Spacious tool bag attached to the belt. Useful when performing any assembly work, etc. It has numerous tool handles and an internal mesh pocket.

Technical data:

Weight:	460 g
Dimensions:	300 x 180 x 350 mm
Material:	PCW
Capacity:	17 L

TA 320

Tool vest

Ref no.: TA 320



REFLECTIVE TAPES



MULTIPLE POCKETS FOR TOOLS



SIDE BUCKLE TO FASTEN



Equipment:

- Made of breathable material that facilitates the breathing of the skin (synthetic technical fabric, distance knitted fabric)
- Convenient adjustment through side buckles
- Reflective stripes
- Easy access to tools, personal items, telephone, documents, etc.
- Available in three sizes: S, M, L

Ref no.:	Waist circumference:
TA320 01	S - 90 cm
TA320 02	M - 94 cm
TA320 03	L - 112 cm

TA 321

Tool harness

Ref no.: TA 321

NEW

COMFORTABLE HARNESS WITH QUICK ACCESS TO TOOLS!



POSSIBILITY DETACHING THE HARNESS FROM THE WAIST BELT



CLIP-ON TOOL POCKETS



Equipment:

- Convenient adjustment
- 2 clip-on tool pockets or other accessories
- Additional tool holders on the waist belt

Technical data:

Weight:	800 g
Size:	universal (S-XXL)
Material:	3D technical spacer fabric, synthetic technical fabric



**GET
BAG**

FULL OFFER OF BAGS,
SACKS AND BACKPACKS

PROTEKT[®]

USE IMAGINATION | PROTECT YOUR LIFE

WWW.PROTEKT.UK

COMPANY ADDRESS

OFFICE

Skromna 6
93-405 Lodz
POLAND

Phone: +48 42 680 20 83

Fax +48 42 680 20 93

SALES DEPARTMENT

Phone: +48 42 29 29 500
export@protekt.com.pl

GPS

51.71280369999999

19.43326209999998

WAREHOUSE

Gombrowicza 6
93-405 Lodz
POLAND

REGISTERED ADDRESS

Protekt Grzegorz Laszkiewicz sp. z o.o.

Skromna 6
93-405 Lodz
POLAND